



Final Report

Reducing herbicide use in row crops with targeted application methods treating detected weeds in small patches or spots

**PCL Ref: R435
HortLink Ref: HL 01102**

Reporting Period: April 2010-December 2012

**Report Authors: Paul C.H Miller and Andrew Lane
(Silsoe Spray Applications Unit), Nick Tillett and Tony Hague
(Tillett and Hague Technology Ltd)**

Report No: 2013/5

No part of this publication may be presented, copied or reproduced in any form or by any means without prior written permission of The NIAB/TAG Group

Intellectual Property Rights are vested in the NIAB/TAG Group on behalf of the Consortium members for LINK project number HL 01102

Potato Council is a registered trademark of the Agriculture and Horticulture Development Board, for use by its Potato Council division.

The following are members of the Consortium for LINK project HL 01102:

Silsoe Spray Apps. Unit (part of the NIAB/TAG Group)

Tillett and Hague Technology Ltd

AHDB Horticulture

AHDB Potato Council

British Beet Research Organization

Robydome Ltd

Hypro EU Ltd

Alistair Findlay and Partners

F B Parrish and Son

Allium and Brassica Centre Ltd

Garford Farm Machinery

Newton Farms

Allpress Farms Ltd

Monsanto UK Ltd

CONTENTS

GROWER SUMMARY	4
Headline.....	4
Background.....	4
Summary	6
Financial Benefits	8
Action Points.....	9
SCIENCE SECTION	10
1. Introduction	10
2. Materials and methods, Results and Discussion	12
(Presented by project objective)	12
2.1 Identify and evaluate options for spray generation.	12
2.2 Identifying spray directing options.....	21
2.3 Development of nozzles - laboratory scale	29
2.4 Design a practical nozzle for field scale experiments.....	33
2.5 Nozzle and experimental rig configurations	34
2.6 Refine detection algorithms	38
2.7 Field trials in a range of crops.....	44
2.8 Economic analysis	58
Conclusions	63
Knowledge and Technology Transfer	64
<i>Papers</i>	64
<i>Presentations</i>	64
<i>Final project demonstration</i>	65
Acknowledgements.....	65
References	664
Appendix 1 : Calculations to examine the economics of operating the system...	686

GROWER SUMMARY

Headline

- A new automated system has been developed to detect and control individual and patches of weeds with low levels of crop damage at commercially acceptable rates.

Background

- EU legislation (e.g. the revision of 91/414 EEC, the EU Thematic Strategy on the Sustainable Use of Pesticides and the Water Framework Directive) has been and is continuing to reduce herbicide availability - the limited range of herbicides remaining does not adequately cover the weed spectrum encountered in horticultural crops and for some weed species there is, or soon will be, very reduced or no approvals for using selective herbicides. There are very few new herbicides in the pipeline even for cereals. This is a particular problem for horticultural crops because high quality is required and growers cannot risk leaving weeds if it could result in crop rejection, loss of product quality and of income.
- Mechanical weed control is now more widely practised, but there are a number of circumstances when these methods are unsatisfactory – in wet weather, and for control of perennial weeds and species with a strong tap root. Chopping up roots of some target weeds such as creeping thistle may exacerbate the problem. Repeated cultivations may also have adverse effects on the environment both in terms of energy use and greenhouse gas emissions. Flame and steam weeding are damaging to invertebrates and consume large amounts of energy. Hand labour has now become expensive and scarce.
- Targeted application of herbicides to weeds that are difficult to control mechanically is an attractive option potentially providing good control with minimum chemical quantities and thus a low cost and environmental impact. Systems for guiding precision banded applications including band spraying are commercially established although only limited work has quantified the spray distribution in narrow bands (see Lund and Jensen, 2002) and the sharpness of the cut-off at the edge of the band.
- Previous work has been successful in developing an image analysis based weed detection system linked to a spot spray control mechanism. This system was initially developed around the specific problem of treating volunteer potatoes within onion, carrot and parsnip crops. Discrimination of live plant material from background was on the basis of colour and a number of criteria were used to determine if plant material

was crop or weed. As implemented during field trials conducted in 2009, these criteria included; distance from crop row (located using a band-pass filter), feature size (volunteer potatoes tend to be larger) and feature shape (overall aspect ratio rather than leaf profile).

- The experimental rig developed in the previous LINK project used a new fluidic nozzle design to generate very large droplets (>1000 µm in diameter) that were applied to detected weed targets to give levels of control in field trials of typically 90 to 95% of volunteer potato plants within the selected size range at the time of treatment.
- While the spot treatment of detected weeds in row crops offers to deliver large savings in herbicide use and maintain good levels of control, there are implications for product approvals where existing approvals or EAMU's are not relevant. For this, and reasons associated with offering greater flexibility and weed control options in a wider range of conditions, there is a need to examine the use of the approach with:
 - All major formulation types;
 - A wider range of weed species;
 - A wider range of crops.
- The major deliverable from this project has therefore been the basis for the design and operation of a commercially viable unit for detecting individual large weeds that can be treated by spot application or patches of smaller weeds that can be patch sprayed particularly in onion, leek and sugar beet crops. The techniques developed will have application to other crops, particularly carrots and parsnips, and a key component of the work has been to develop a system that will operate with a wide range of herbicide formulations.

Summary

1. This LINK project has built on the results from a previous LINK project (Miller et al., 2010) that specifically addressed the issue of controlling volunteer potatoes in crops of onion, carrot and parsnip and demonstrated the feasibility of detecting and applying a targeted herbicide dose to such targets.
2. The current project aims to extend the approach developed in the earlier work so as to:
 - Enable a wider range of formulation types to be used;
 - Address a wider range of target weed species in a wider range of crops particularly onions and leeks;
 - Have the ability to treat patches of weeds as well as using spot applications directed at single weeds.
3. An existing field rig was modified for use in field trials that were conducted as part of this project.
4. A new nozzle cartridge system was designed in the first year of this project and successfully developed and used in field trials during the second season of the project work. The cartridge unit enables one of two nozzle tip designs to be fitted, namely:
 - (a) a version of the “Alternator” nozzle design creating very large droplets appropriate for treating large weeds with spot applications;
 - (b) an “Even-spray” tip generating a medium/fine quality spray appropriate for treating small weeds (e.g. grass weeds at an early stage of growth) when detected as patches in row crops.

The decision to develop the cartridge approach with two nozzle tips was taken after measurements with different nozzle designs in the first year of this project showed that it was not possible to achieve the range of spray characteristics needed for both spot and patch application from a single nozzle design. Further measurements of the droplet size distributions from both the “Alternator” and “Even-spray” tips were made in the second year of the project and confirmed that the “Even-spray” tip would create a fine spray at pressures above 3.5 bar. Some problems with leakage between components of the cartridge assembly were identified during the work in the second season of the project and addressed by re-molding some parts in a different, more compliant, plastic material.

5. A review of the options for controlling spray movement from nozzle to target concluded that, for spot application, the use of large droplets delivered with a controlled trajectory was the best option. For application to patches where a medium/fine spray quality is needed, less control may be needed when selective herbicides are applied and trajectory control is probably still the most appropriate. Studies in this second year of the work investigated the potential for crop contamination by splash and concluded that for most formulation types the addition of components to modify the physical properties of the spray liquid (e.g. viscosity) was not justified.
- 4 A new solenoid valve developed during the first year of the work in conjunction with the valve manufacturer proved to be significantly more reliable when used with emulsion based formulations than the version used previously and which was specified for water soluble formulations such as glyphosate.
5. Weed detection algorithms have been developed throughout the life of the project based on increased field experience. Work in the first year of the project developed an algorithm for weed patch detection in vegetable crops based on determining a green area index for the inter-row region. Options for discriminating weeds based on sensing height were also examined. Work in the second year specifically involved the development and construction of a stereo camera system particularly for the detection of weed beet by height discrimination. Preliminary analysis of image pairs collected in field conditions have gave promising results, but the stereo analysis algorithms will require further refinement if the technique is to progress to a practical sensing technique. Assessments of the performance of the weed patch detection algorithm were conducted in a crop of rape established with a wide (500 mm) row spacing in year two of the project and in a sugar beet crop in year three.
7. Field experiments conducted during the project:
 - a) Confirmed that high levels of control (>90%) of large weeds such as volunteer potatoes in onion and leeks could be achieved by spot application of selective and non-selective herbicides. Non-selective formulations gave a more rapid and complete weed kill with acceptable levels of crop damage.
 - b) Showed that spray deposits on target weeds treated by spot application were at least an order of magnitude greater than on crop plants in the vicinity of treated weeds from assessments made in the onion crop in the 2011 season and in leeks in the 2012 season.

- c) Confirmed that the experimental rig, in its final configuration, was able to operate in a wide range of crop conditions with different herbicide formulations and mixtures relevant to the treatment of a range of weed species as spots or small patches.
 - d) Showed that herbicide residues in leek crop plants in the immediate vicinity of weeds targeted in spot treatment applications were below the level of detection at the time of harvest confirming provisional results from a previous project in onions, carrot and parsnip crops.
 - e) Investigated the treatment of weed beet by simulating spot application to the base of a detected plant deflected forwards by a rubbing bar. Results from this work showed that variable levels of control were likely with no correlation between the response to the application and weed size and the amount of leaf at lower levels on the weed.
8. A key factor influencing the commercial uptake of the system relates to the regulatory position concerning herbicide use. Discussions held with The Chemicals Regulation Directorate as part of project work and followed up by staff from The Horticultural Development Company have resulted in an EAMU relating to spot application in a range of vegetable crops being issued.

Financial Benefits

A cost benefit analysis has been made based on experimental data, knowledge of engineering costs and general farm economic information derived from Nix (2011)) and partner growers. It is assumed that the precision spraying technology developed in this project would be implemented as an additional capability to a vision guided band sprayer. This is important economically as it allows the machine to be utilised for a larger proportion of the season than would be the case if its only function was the control large broadleaf weeds. Three different scenarios are compared for each of the three crops covered in this project. The proposed new strategy using a combination of spot, band and overall spraying compares favourably (18% saving) with the current weed control strategy in leeks and indicates a 40% saving over the projected situation in 2015. The situation in onions is similar to that of leeks except that the current herbicide situation is slightly better in onions and so there generally no need for inter-row cultivation which is a relatively expensive operation. The new strategy represents a 1% saving over the current situation and a 40 % saving over the projected situation in 2015.

Action Points

The project has developed and validated the technology necessary for the production and operation of a commercial prototype system for the detection and treatment of large weeds by spot application and patches of weeds using patch spraying approaches. It is expected that the commercial partners involved with the project will now develop commercial prototype machines for evaluation by growers in response to demand for such systems.

SCIENCE SECTION

1. Introduction

This report details the results of a LINK project that aimed at further developing and demonstrating the technology that uses weed detection and the targeted application of minimum quantities of herbicide formulations to control a range of weed species in a range of vegetable crops, particularly onions and leeks. The project also investigated the application of the approaches developed to the control of weeds in the sugar beet crop including weed beet. The study followed an earlier LINK project that was specifically concerned with the control of volunteer potatoes by the targeted application of a total herbicide.

The background to the project was given in previous reports (Miller et al, 2006; Miller et al, 2010) and included the following main points.

- (a) The need to control volunteer potatoes in vegetable crops relates to both yield and quality considerations that are difficult to quantify in financial terms because of the variability in growing situations. Control of volunteer potatoes is also important in relation to the carry-over of disease in the potato crop.
- (b) Significant progress has been made in the last decade in relation to the use of image analysis for machine guidance and control particularly leading to the commercial introduction of the Garford “Robocrop”.
- (c) Weed detection has been the subject of much research effort aimed at developing systems that will minimize pesticide use. The most successful approaches have been those operating in widely spaced row crops including vegetables.
- (d) There is little published information about the performance of wiper applicators in terms of herbicide transfer or crop contamination. The height differential between weed and crop is crucial to the performance of such systems and accurate control of operating height is therefore necessary.
- (e) Pulsed nozzle designs have been developed for selective chemical thinning operations and, although not exploited commercially on a wide scale, some of the under-pinning research is relevant to the current project.

Work in the previous LINK project (Miller et al, 2010):

- (i) Developed methods for weed detection in row crops based on image analysis that defined the position of crop rows, identified the positions of relatively large weed plants with respect to the detected rows and defined a treatment area (as a polygon) around each detected weed;
- (ii) Developed nozzle systems for spot application that would minimize contamination and damage to crop plants close to treated weeds: specifically work, mainly by Hypro EU Ltd, developed a nozzle, to be known as the “Alternator” nozzle, operating on fluidic principles to create very large droplets (mean size >1000 µm) delivered from a narrow well defined spray fan operating at relatively low pressures (<1.0 bar);
- (iii) Conducted field trials in crops of onion, carrot and parsnip examining the control of volunteer potatoes using applications of the total herbicide, glyphosate: Results from these field trials showed that the system was able to achieve high levels of control (90-95% of weeds above the size threshold at the time of treatment) with levels of crop damage that were judged to be commercially acceptable.

Work in this project has aimed at extending this approach to a wider range of weed species in a range of crops using a wider range of formulation types and herbicide mixtures. The work has involved:

- (i) Reviewing options for generating sprays appropriate for the treatment of a range of weed sizes recognizing that applications to large weed targets would require a nozzle capable of generating very large droplets with relatively low release velocities while small grass weed targets should be treated with a nozzle capable of generating a spray with a medium/fine spray quality.
- (ii) Reviewing options for controlling spray movement between nozzles and target so that target deposition would be maximized with the minimum contamination of crop plants close to treated weeds.
- (iii) The development of nozzles appropriate for the spot and/or patch application of a range of herbicide formulation types and mixtures to detected weed targets.
- (iv) The design of nozzles and control systems, including solenoid valves, that would be appropriate for use on a commercial design of machine for “intelligent band spraying” that would include a spot spraying option.

- (v) The modification of an existing experimental rig so as to facilitate field trials with the proposed spot and patch application systems in a range of crop conditions, treating a range of weed species using different herbicide spray liquids.
- (vi) Revising the weed detection algorithms developed in previous work and developing new algorithms so as to:
 - improve the accuracy of detection of a range of weed species and treatment;
 - detect patches of small weeds in row crops;
 - detect weeds without reference to crop rows.
- (vii) Conducting field trials with both selective and non-selective herbicides assessing levels of weed control, damage to crops and residues within crop plants.
- (viii) Undertaking an economic assessment of the proposed systems so as to establish the likely commercial viability of the proposed approaches including discussions with representatives of the Chemicals Regulation Directorate such that issues relating to the approvals of products for spot and patch application in a range of vegetable crops, particularly the total herbicide glyphosate, can be addressed via an EAMU.

2. Materials and methods, Results and Discussion

(Presented by project objective)

2.1 Identify and evaluate options for spray generation.

An analysis of the requirements for spray generators to deliver herbicides to both individual detected weeds as a spot treatment and to treat patches of weeds indicated that there was need to be able to deliver sprays with a wide range of spray qualities (droplet size distributions). Previous studies as part of a LINK project (Miller *et al.*, 2010b) had shown that large weeds (volunteer potatoes) could be effectively treated using sprays from a fluidic nozzle design that generated very large droplets (>1000 μm) that were well outside the range used to classify the performance of agricultural spray nozzles (Doble *et al.*, 1985). These large droplets gave good control of the drift risk even in wind conditions that were above those regarded as satisfactory for crop spraying. It can be concluded that such sprays are appropriate for the treatment of relatively large weeds that are detected and treated as spots. However, the requirement to treat patches of weeds may involve herbicide applications to much smaller weed target such as grass weeds at an early stage of growth. A number of studies (e.g. Miller *et al.*, 2010a) have shown that spray retention on such small

targets is a function of droplet size and that a droplet size representative of the fine/medium spray quality in the BCPC classification scheme (Doble *et al.*, 1985) is needed if high levels of retention are to be achieved.

In considering spray generation systems that could be used for applications to both spot and patch targets it was therefore necessary to consider systems that could create sprays with very large droplets for spot application and a medium/fine spray quality for treating patches of smaller weeds. The option of using a single nozzle design to deliver the full range of spray qualities required was initially explored by examining the performance of the fluidic “Alternator” nozzle over a wider range of operating pressures.

2.1.1 Further measurements with the fluidic “Alternator” nozzle

Measurements of the droplet size distribution with the original design of the “Alternator” nozzle operating at pressures up to 9.0 bar showed that increasing the pressure decreased droplet size as expected (Figure 1). Measurements were made with the nozzle supplied both from a pump and from a pressurized canister because it was thought that small pressure pulsations in the supply from a pump may influence the performance of the nozzle. Results indicated no differences when the supply was from the pump or pressurized canister (Figure 1).

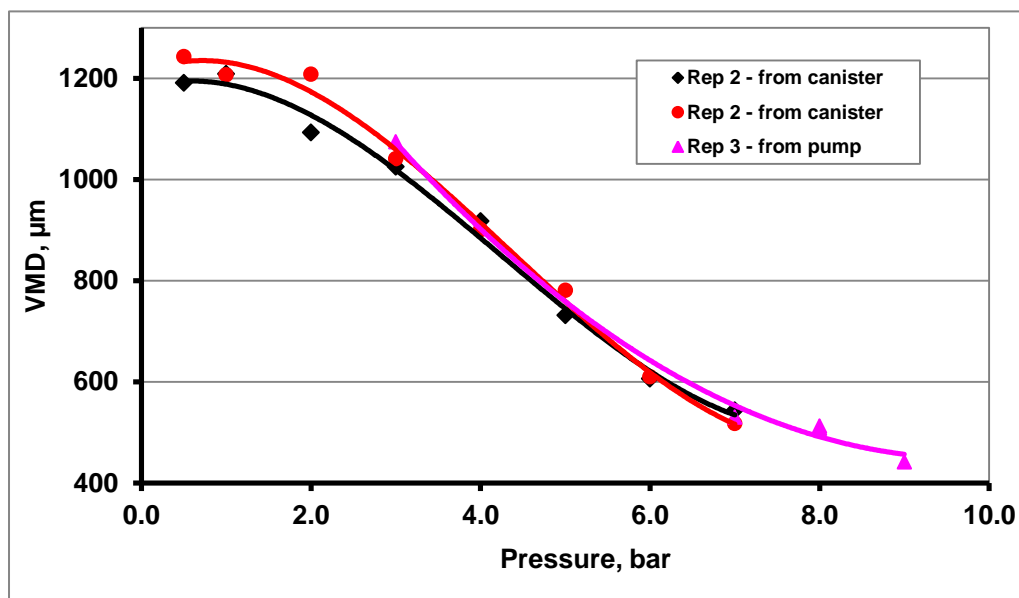

Figure 1. The mean droplet size (as Volume Median Diameter) from the “Alternator” nozzle at different pressures

The reduction in mean droplet size did not give a VMD value for the measuring system used (Oxford Lasers Ltd “Visisizer” with the spray scanned by moving the nozzle on an x-y transporter – see Tuck *et al.*, 1997) that was comparable with that of a fine/medium spray quality sampled in the same way (VMD of 272 μm). However, it was recognized that the effective spray fan angle from the “Alternator” nozzle design was much narrower than that for the conventional reference nozzle designs and therefore the droplet size distributions were further analysed to compare the droplet size/flux relationships that would be relevant to a 60 mm wide strip immediately below the nozzles. The droplet size distributions plotted in Figure 2 show that, as the pressure is increased, the distributions span a wider range of droplet sizes with evidence of bi-modality for the “Alternator” design particularly at pressures of 3.0 and 5.0 bar. At a pressure of 8.0 bar the proportion of spray volume in droplets around <400 μm in diameter is increased but there is still a substantial proportion of the spray in very large droplets particularly when compared with conventional nozzles giving a fine or medium spray quality – see Figure 3.

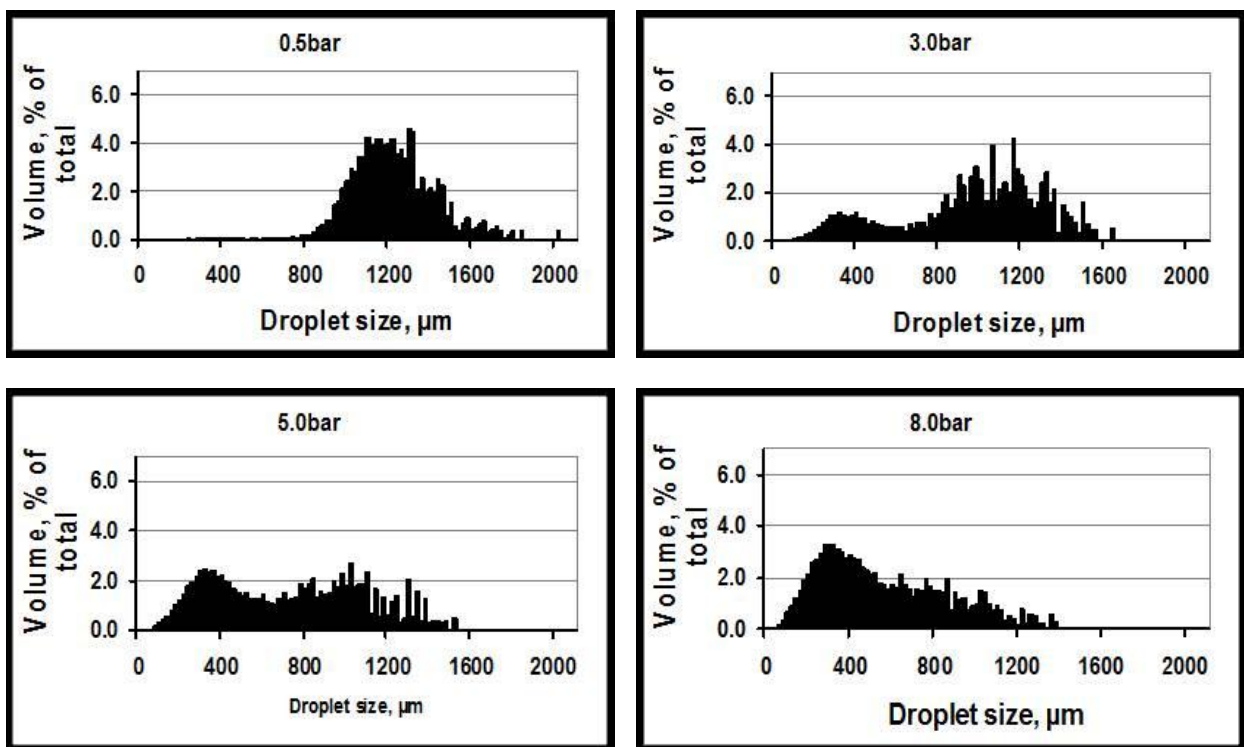

Figure 2. Droplet size distributions from the “Alternator” nozzle at different pressures

An analysis of the flux on a 60 mm wide strip below the nozzles is summarised in Table 1 and shows that, at a pressure of 8.0 bar, flux values from the “Alternator” nozzle in the 100 to 200 μm range are comparable with those from the conventional flat fan nozzles.

However, the presence of the larger droplets in the spray could influence the efficacy when treating small targets and will represent a reduction in efficiency of the application process.

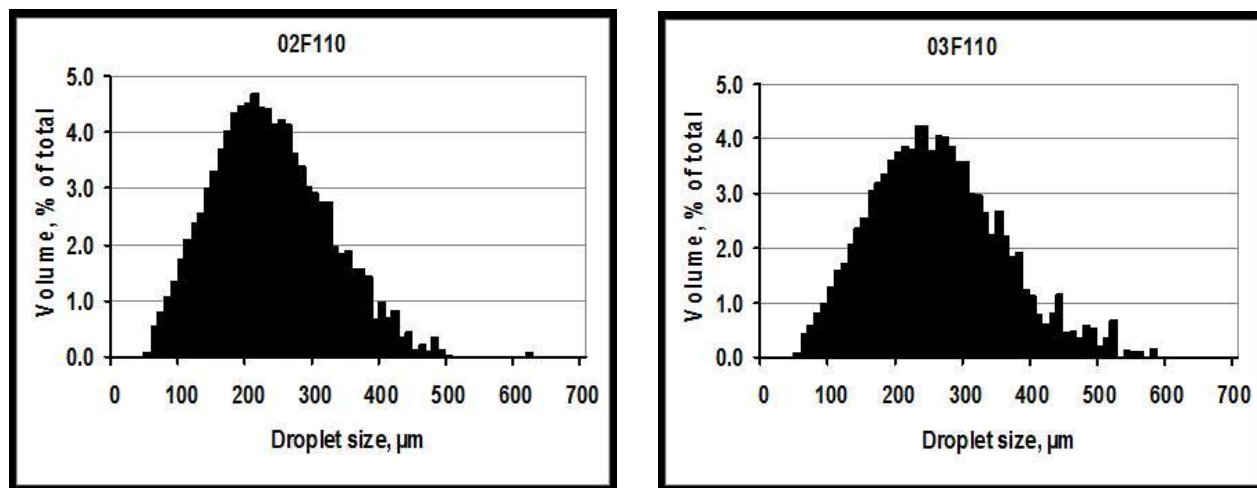

Figure 3. Droplet size distributions measured with conventional nozzles operating at 3.0 bar pressure to give fine (02F110) and medium (03F110) spray qualities.

Table 1. Comparison of flux levels on a 60 mm wide strip sprayed with different nozzle conditions

Nozzle	Flow rate, L/min	% vol in 100 – 200 µm	Flux in 60 mm wide strip in 100 – 200 µm, L/min
“Alternator” at 0.5 bar	0.135	0.05	0.000068
“Alternator” at 8.0 bar	0.507	6.18	0.031
“02” 110° Flat fan	0.83	32.38	0.033
“03” 110° Flat fan	1.12	24.96	0.036

It was also recognized that droplet velocities may be important particularly with regard to droplet splash from the target. Measured droplet velocities for the “Alternator” nozzle plotted in Figure 4 show the expected increase in velocity of the main part of the spray with increasing pressure over the range 0.5 to 8.0 bar.

It was concluded that although operating the “Alternator” nozzle at increased pressures moved the performance envelop towards that required to treat a range of weed targets, it was not appropriate to use this nozzle design to treat all of the targets needed with a spot and patch spraying system with particular issues relating to weeds.

the treatment of small

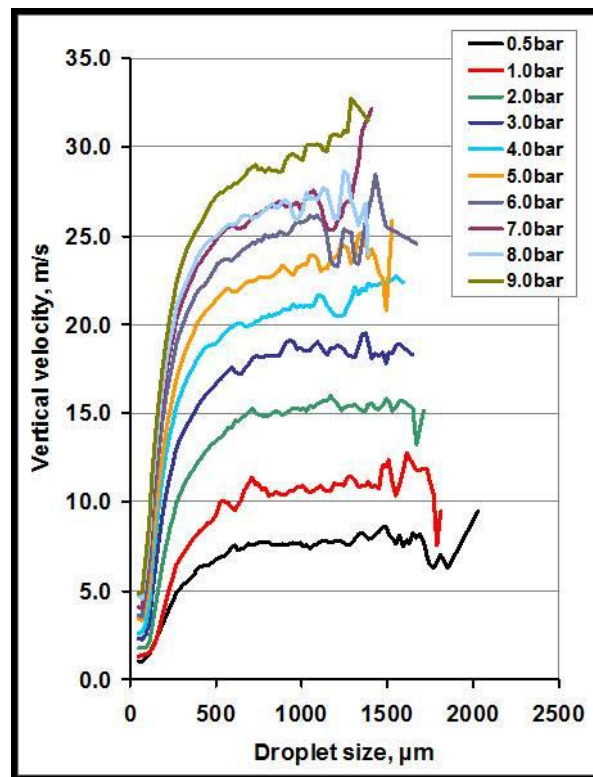

Figure 4. Measured droplet size/velocity profiles for the “Alternator” nozzle with the spray sampled 250 mm below the nozzle outlet.

After considering the range of alternative options for generating a spray, it was decided that:

- Large weed targets that can be treated with spot applications should use a nozzle capable of generating very large droplets with relatively low release velocities and that the “Alternator” design operating at low pressures (1.0 bar or less) was appropriate for such applications; the nozzle should then have a spray angle in the order of 15 to 25° (lower spray fan angles will allow the nozzles to be operated at greater heights) and a nominal flow rate at the working pressure in the range of 0.3 to 0.4 L/min (lower flow rates than this range would involve smaller output orifices and so pose an unacceptable risk of blocking when operating with a range of formulation types);
- Weed patches that may include relatively small weed targets including grass species at early stages of growth should be treated with a nozzle capable of generating a spray with a medium/fine spray quality and that an “Even Spray” tip was appropriate for such

applications; this nozzle to have a flow rate and spray angle specification similar to that of the “Alternator” nozzle as defined above.

For conventional flat fan and “Even Spray” nozzles, the mean droplet size increases as the orifice size (and therefore flow rate at a given pressure) increases and as the spray fan angle decreases. It was not therefore obvious whether an “Even Spray” nozzle with a small orifice size and small spray fan angle would generate fine/medium quality sprays at an appropriate range of operating pressures. To examine the potential for such a design to achieve the required performance, a prototype unit was made by Hypro EU Ltd using a resin setting system operating in conjunction with a computer-aided design system and the performance measured with established techniques.

2.1.2 Measurements of the performance of a resin-based prototype “Even Spray” nozzle design

The results from droplet size measurements made with a laser-based analyser (Oxford Lasers “Visisizer” – see Tuck *et al.*, 1997) with the nozzle mounted on an x-y transporter system so that the whole of the spray could be sampled, showed that the “Even Spray” design could generate a fine/medium quality spray at a pressure of approximately 3.5 bar – see Figure 5. The results are plotted on a spray quality grid generated from measurements with reference nozzles using the same instrument and sampling procedures.

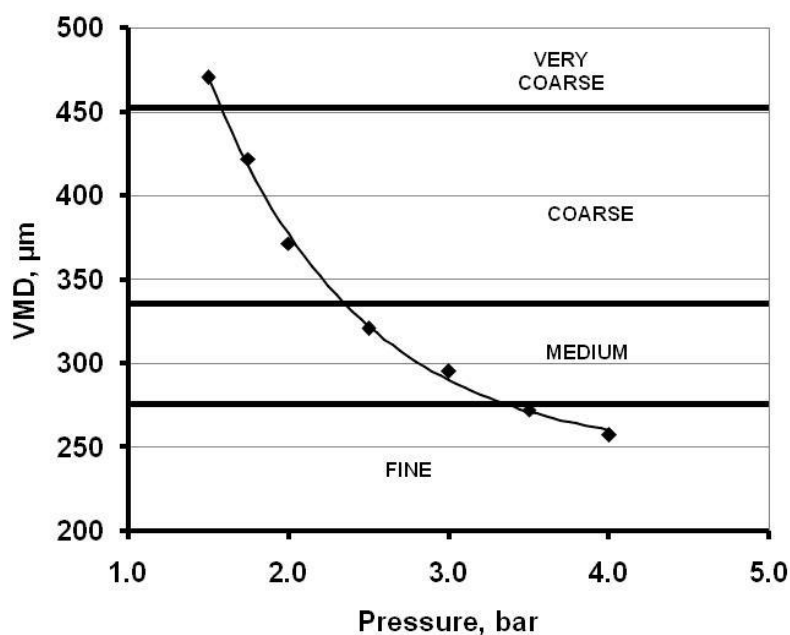
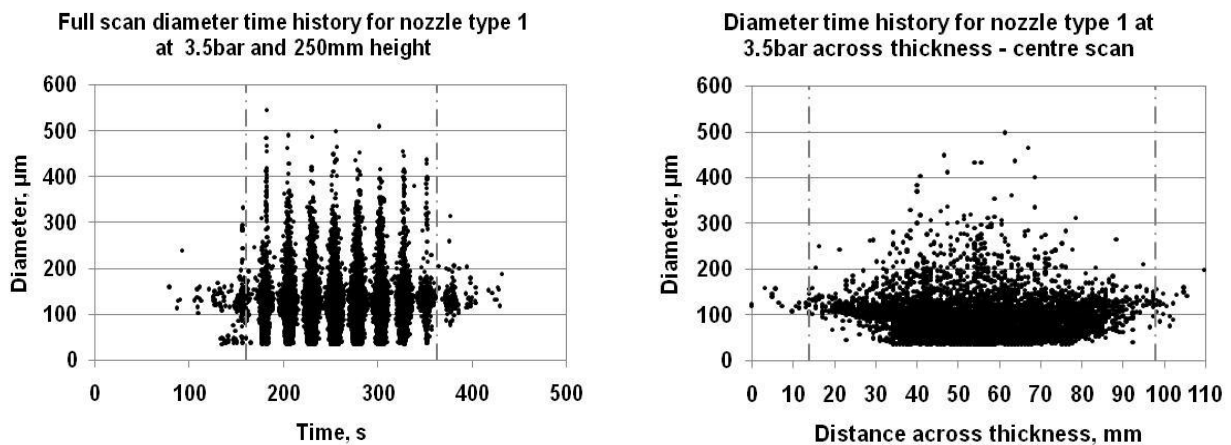

Figure 5. Mean droplet sizes (as a Volume Median Diameter) for the prototype “Even Spray” nozzle compared with results from reference nozzles defining spray quality classes of fine, medium, coarse and very coarse.

Results from detailed measurements of the spray structure from the prototype “Even Spray” nozzle operating at a pressure of 3.5 bar and sampling 250 mm below the nozzle are shown in Figure 6. These results show that the spray had a fan angle (across the spray fan) of 24° and an angle through the centre of the fan of 19° with a cut-off at the edge of the pattern that



was less sharp than for the “Alternator” design as expected.

Figure 6. Results from detailed measurements of the spray structure with the resin-based prototype “Even Spray” nozzle.

2.1.3 Studies with a sprinkler jet (streaming) nozzle for spot application

A potential alternative to the “Alternator” nozzle design based on six individual fixed jets that would combine to give an effective spray fan angle of 14.2° was investigated to:

- a) Determine the extent to which such a design would enable both the small droplet component and the velocities in the spray to be reduced and improve target deposits;
- b) Provide a test unit that could be used to compare measured results with those from theoretical analyses of spray formation.

Initial experiments were conducted using sections of hypodermic needles mounted in a base unit. An experimental unit was subsequently fabricated by Hypro EU Ltd based on drilling 0.4 mm diameter holes in a 3.5 mm thick brass plate that was then mounted on a connecting unit enabling a liquid supply to be connected to the back of the brass plate. Measurements of the droplet size and velocity distributions were then made when operating with tap water

at pressures of 0.3, 0.5, 0.75 and 1.0 bar using the Oxford Lasers “Visisizer” system and moving the nozzle to ensure that all of the jets were effectively sampled.

The results plotted in Figure 7 show that this method of spray formation gave a substantial number of small droplets (<250 μm in diameter) but that these accounted for a very small percentage of the volume output from the nozzle. Mean droplet sizes did not vary significantly over the range of pressures tested with volume median diameters in the range 1060 to 1100 μm . Droplet velocities plotted in Figure 8 increased with increasing pressure as expected but with values that tended to be slightly higher than those from the “Alternator” nozzle operating at comparable pressures (see Figure 4).

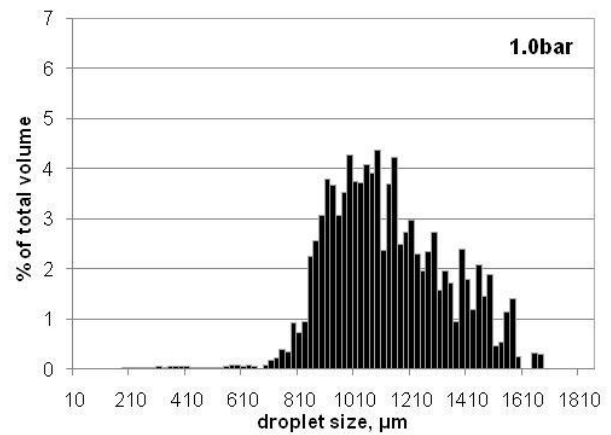
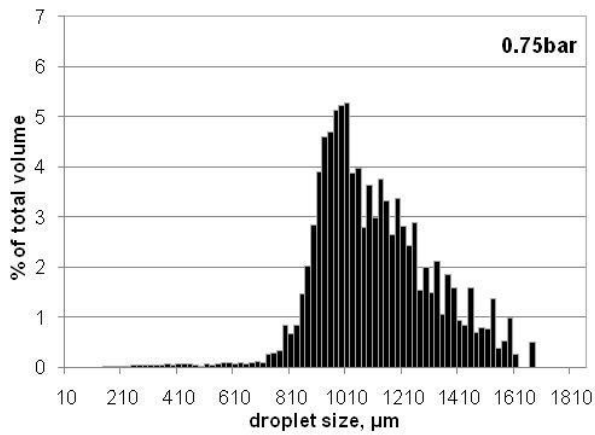
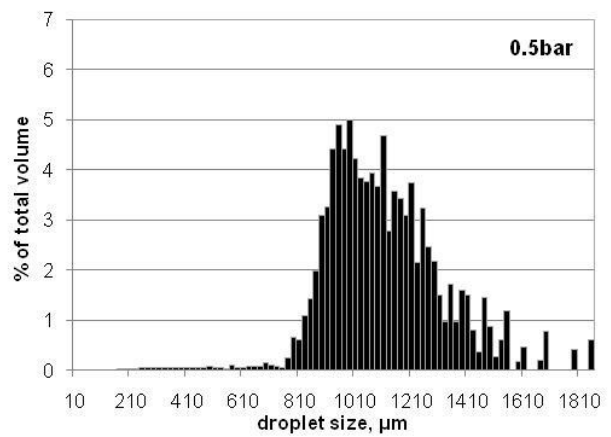
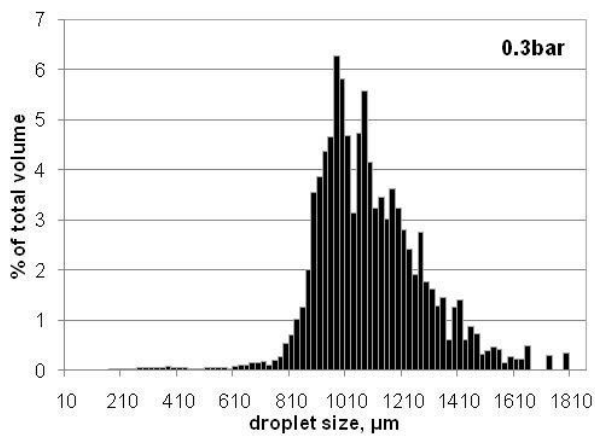
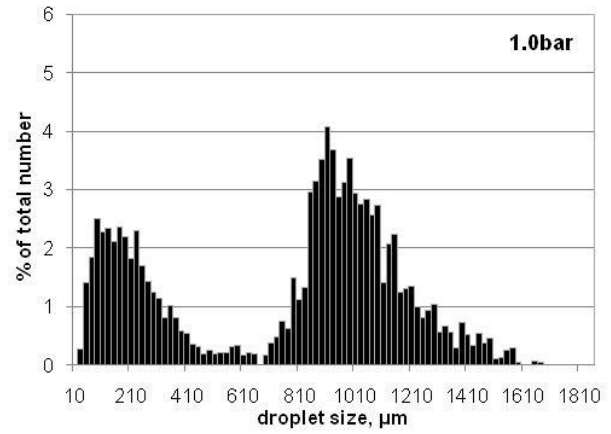
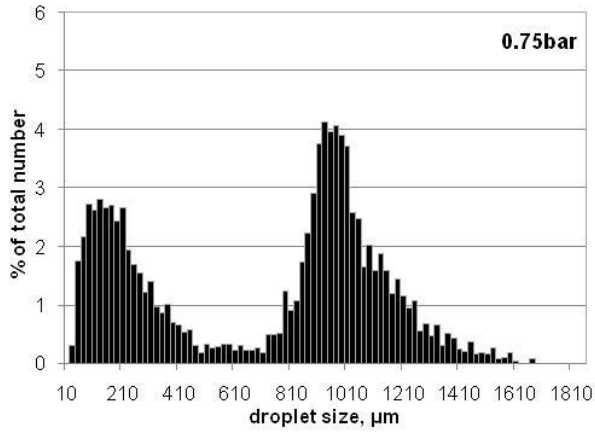
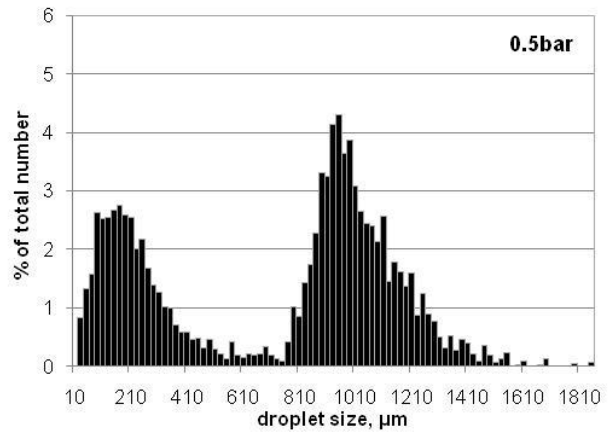
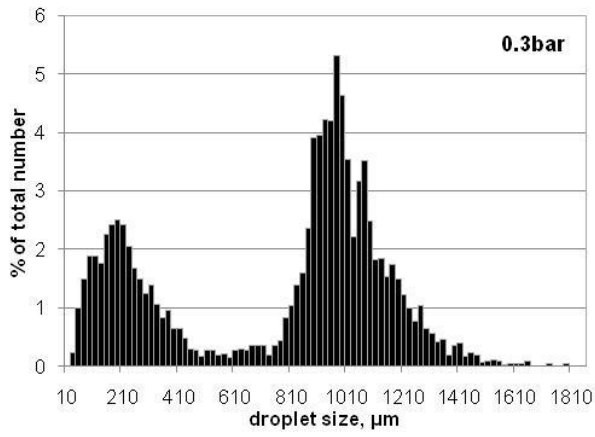
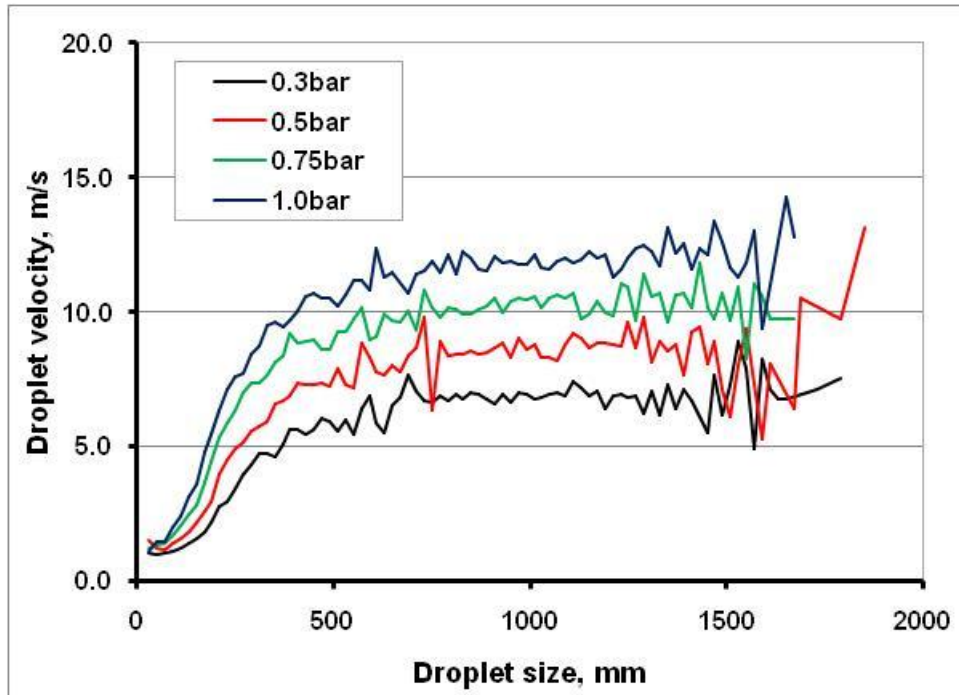

Figure 7. Droplet size distributions measured at different pressures for the streaming nozzle



expressed as droplet numbers (upper) and spray volume (lower).

Figure 8. Droplet velocities measured with the streaming nozzle.

The measurements of droplet size and velocity were made at 250 mm below the nozzle orifice. The results presented in Figure 8 indicate that even when operating at the lowest pressures, droplet velocities from the streaming nozzle are not substantially lower than from the “Alternator” design.

It was recognized that the streaming nozzle would use a smaller orifice size than for the “Alternator” design and that this may cause blockage problems particularly when using formulations that are not complete solutions. It was therefore concluded that the “Alternator” design was the most appropriate for spot applications to large target weeds using a range of herbicide formulations and tank mixes.

2.1.4. Theoretical considerations

In an idealized situation, the breakup of a liquid jet depends upon the ratio between two dimensionless numbers: the Reynolds Number and the Ohnesorge Number (Lefebvre, 1989). Both these numbers are derived from measurements of the physical properties of the spray liquid (e.g. density and dynamic viscosity) and the dimensions of the jet. At low values of both numbers, jet breakup occurs in a mode defined by Rayleigh in which the main droplet size is 1.89 times the diameter of the orifice from which the jet is formed. In the idealized case the droplets are mono-dispersed (all the same size) but in practice satellite droplets are often formed between the main droplets such that the resulting droplet size distribution is bimodal. At higher values of both numbers, breakup occurs by wave interactions with air movements (atomization) and the resulting mean droplet size is less than the diameter of the orifice. In the spot spray application, if jets could be formed that breakup in the Rayleigh mode, then the number of small droplets formed could be very small and the risk of crop contamination minimised. Plots of the ratio between Reynolds Number and the Ohnesorge Number were calculated for both the “Alternator” and the streaming nozzles when operating with tap water and the results showed that in both cases the breakup was close to the transition between the Rayleigh mode and atomization. Inspection of the results plotted in Figure 7 for the streaming nozzle indicates that this nozzle was operating in the Rayleigh mode but with a substantial number of satellite droplets. This probably reflects a realistic breakup pattern rather than a theoretical one and suggests that the idealized theoretical breakup mode would be difficult to achieve in practice. For the “Alternator” design, the form of the outlet orifice is more complex than is assumed in the theoretical models but both calculations of the two dimensionless numbers and inspection of the data in Figure 2 indicate that breakup is just within the atomization mode. At pressures of 3.0 and 5.0 bar, the droplet size distributions based on volume do show a bimodal characteristic suggesting that the breakup of the oscillating stream at these pressures involves some primary breakup with a wind/wave component but also some satellite droplet formation.

It was concluded from the theoretical analysis that:

- The option of using Rayleigh breakup as a mechanism for forming relatively large droplets for spot applications with a minimum of small droplets using a streaming nozzle design is limited because practical jet breakup will often mean the formation of some small satellite droplets;
- Options using larger output orifices (when compared with the streaming nozzle) and some spray distributing mechanism (as in the “Alternator” design) are unlikely to give droplet size distributions close to that theoretically defined by Rayleigh breakup with spray formation more likely to be in the atomization mode with a substantial wind/wave component to the breakup mechanism.

2.2 Identifying spray directing options

It was recognised that there were two possible mechanisms by which spray could be deflected from target weeds to crop plants particularly when making spot applications, namely:

- a) Direct displacement of the spray pattern by air movements, mainly the natural wind;
- b) Secondary splash following initial contact with the target.

The control system was programmed to account for the response characteristics of the control valve, the time to establish a spray and the horizontal component of droplet velocities that result from the forward motion of the machine.

Four main options were considered for directing the spray from a nozzle to the target with the aim of minimising the displacement of the spray pattern due to air movements and therefore crop contamination and damage.

2.2.1 The use of droplet trajectories

Where large droplets are generated, as for example by the “Alternator” nozzle, then sprays can be directed to the target by controlling the initial velocity and angle of release from the nozzle. Studies in the previous LINK project indicated that designs of the “Alternator” nozzle could maintain droplet trajectories from a moving nozzle in wind speeds up to 3.0 m/s at nozzle height and hence minimise crop contamination due to drift. The fine/medium quality spray from the “Even Spray” nozzle is likely to be more influenced by wind effects although

the applications based on patch treatments are also likely to be less sensitive to off-target contamination effects.

2.2.2 The use of electrostatic charging

Electrostatic charging has been shown to control the movement of small droplets and in agricultural spraying applications has given deposits on under-leaf surfaces and stems that are difficult to achieve by other methods. However, the technique is most effective when:

- using small droplets (circa 100 μm in diameter or less);
- when operating with strong electrostatic fields that can be generated externally (as for example on a potato roller table) or from an induced field as a result of a cloud of charged droplets.

Such small droplets and high electrostatic field strengths are unlikely to be relevant to spot and patch spraying in agricultural environments and it was considered that such approaches were not appropriate for further development, experimentation and evaluation as part of this project.

2.2.3 The use of controlled air flows

The use of air flows to control spray trajectories has been used in horticultural and agricultural applications and has been shown to reduce the risk of drift. The design of such systems needs to recognise:

- (i) The need to match air flow characteristics to the crop/weed canopy to be treated so as to avoid bounce;
- (ii) The relationship between the spray source and the air flow such that the air does carry spray to the target;
- (iii) The power requirements associated with moving high volumes of air.

It was concluded that air-assistance may have a role if work later in the project, particularly with the fine/medium quality spray from the “Even Spray” nozzle, showed that control over spray movement other than by controlling the initial trajectories was needed.

2.2.4 The use of physical shields

The use of shields and side guards is well established for operation with band spraying applications and would provide control across crop rows. As with air-assistance, it was concluded that such guards would not be required if the droplet size distribution and trajectories could be adequately controlled.

2.2.5 Measurements of spray displacement due to wind

Experiments were conducted in conjunction with staff from the University of Southern Denmark to establish the likely spray patterns on a treated spot and the downwind displacement of the pattern if existing conventional nozzles were pulsed with a solenoid valve arrangement. These results were then compared with those when using the “Alternator” nozzle and latching solenoid in comparable conditions.

A Spraying Systems “TP 6502” nozzle was mounted on a transporter system in the wind tunnel on the Silsoe site (Figure 9) such that the nozzle tip was 400 mm above an artificial grass surface and an array of strips of chromatography paper as collectors. The transporter was calibrated to move the nozzle assembly across the tunnel at a speed of 2.0 m/s and this was monitored using micro-switches on the transporter beam. A spray liquid supply was arranged from a pressurized container to feed the nozzle assembly with water plus a tracer dye at a pressure of 2.2 bar. A system for pulsing the control solenoid based on a proximity detector and a length of metal bar mounted on the transporter was set up.

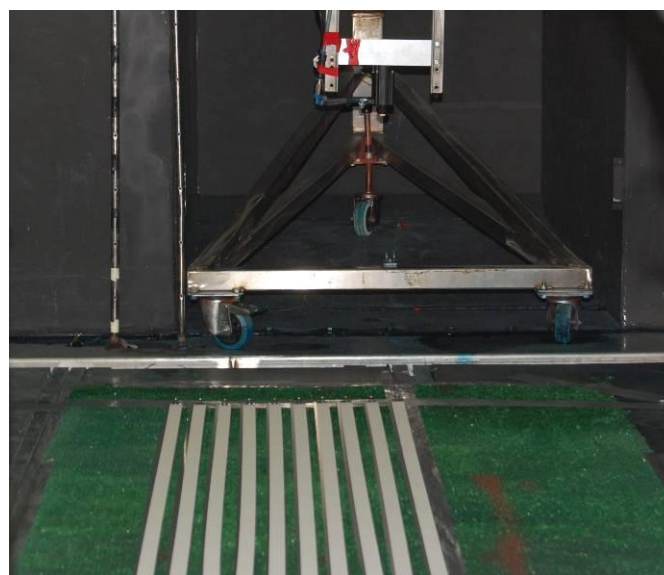

Figure 9. Nozzle assembly mounted in the wind tunnel showing the sampling array of chromatography strip collectors.

Measurements made with the conventional nozzle system operating in still air conditions and wind speeds of 2.0 and 4.0 m/s shown in Figure 10 show the expected trends, namely that:

- i. The deposit distribution tapers at the edge of the pattern;
- ii. The pattern is deflected in the downwind direction by the action of the wind.

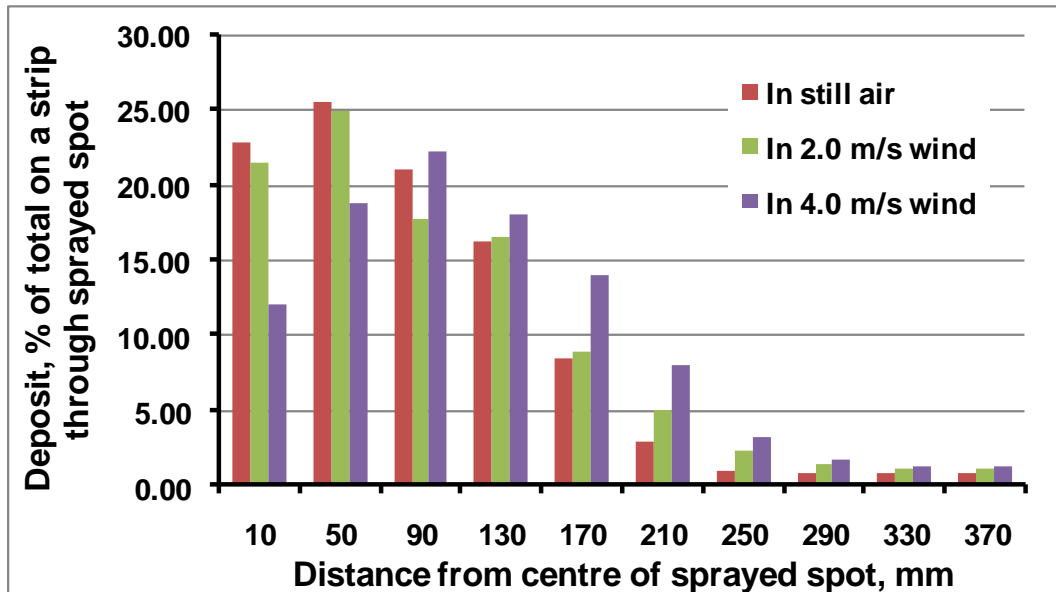

Figure 10. Spray pattern results for a pulsed conventional nozzle assembly.

The equivalent results to those for a conventional nozzle plotted in Figure 10 but for the “Alternator” nozzle design are plotted in Figure 11.

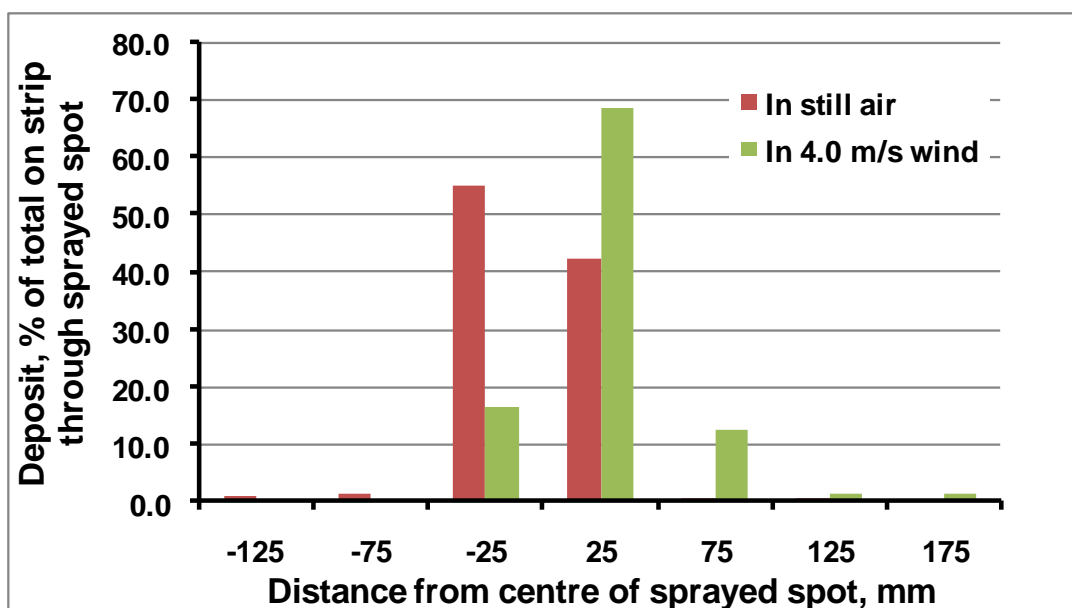

Figure 11. Spray pattern results for a pulsed “Alternator” nozzle assembly.

The results in Figure 11 show that the deposition pattern from the “Alternator” nozzle had a much sharper cut-off at the edges of the pattern as expected. There was some displacement of this spray pattern when operating in the wind tunnel with a wind speed of 4.0 m/s with the centre of the pattern being displaced by some 37 mm in the downwind direction.

It was recognized that the wind conditions used in the tunnel were extreme because:

- A 4.0 m/s wind speed at boom height represents the highest speed on most spraying charts and these indicate that spraying should not be conducted at such wind speeds;
- The wind tunnel air speed profile was approximately uniform with height with only a small reduction in wind speeds close to the floor of the tunnel whereas a field condition would involve a logarithmic air velocity profile and significant air speed reductions close to the ground surface.

It was therefore concluded that for most spot spraying applications, adequate control of droplet trajectories would be achieved by using large droplets such as generated by the “Alternator” design with the minimum of spray volume in droplets <200 µm in diameter and with a downward velocity in the order of 10.0 m/s. If additional protection from air movements were to be required then this could be achieved by using side guards.

2.2.6 Possible effects due to splash from a target weed

The performance of the spray direction control options, particularly in relation to the risk of splash from the target surface when using the “Alternator” and “Even Spray” nozzles was assessed in a series of wind tunnel experiments. A single nozzle was mounted on a transporter and moved across a tray that contained a single target plant (sunflower) at a speed of 4.0 km/h. The nozzle was arranged to deliver a pulse of spray of a tracer dye to the target plant. The movement of spray to under and either side of the plant due to splash and drift was monitored by using 25 mm wide strips of chromatography paper placed with a 10 mm gap between strips such that the spray distribution over a region 300 mm wide could be mapped by analysing spray deposits using spectrophotometry. Dye deposits could also visualised on the collecting papers – see Figs. 12 & 13.



Figure 12. Dye deposits monitored on a plant surface treated with the “Alternator” nozzle operating 400 mm above the target, at a pressure of 0.75 bar and travelling at a speed of 4.0 km/h in still air conditions. (Note: Little evidence of secondary splash from treated leaves).



Figure 13. Dye deposits monitored on a plant surface treated with the “Even-Spray” nozzle operating 400 mm above the target, at a pressure of 3.0 bar and travelling at a speed of 4.0 km/h in still air conditions. (Note: The larger footprint compared with the “Alternator” nozzle and little evidence of secondary splash from treated leaves).

Results from these experiments showed little evidence of splash from treated leaf surfaces with either nozzle with most of the spray being deposited within a 100 mm wide strip centred on the target plant (Fig 14). Plant leaves were shown to good interceptors of the spray with penetration through the plant only corresponding to gaps between plant leaves.

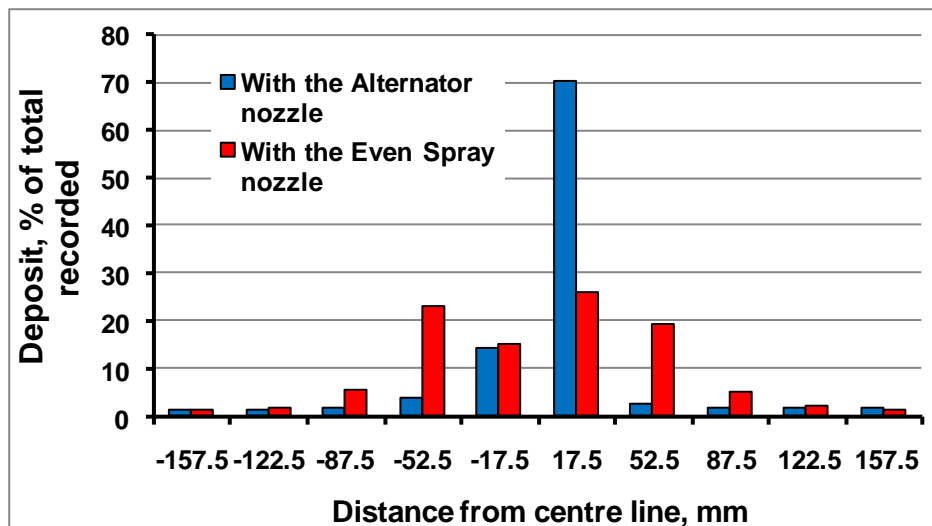

Figure 14. The distribution of measured deposits around a treated weed (mean values from three replicated measurements).

The results plotted in Fig. 14 confirm the differences in the spray volume distribution pattern produced by the two nozzle designs. This was also reflected in the measured deposits on the target plants with values of 45.3 and 31.9 μL of dye per gramme of plant weight being measured for plants treated with the “Alternator” and “Even Spray” nozzle respectively. There was little evidence that splash gave deposits substantially away from the targeted plant with the measured values at distances greater than 120 mm from the centre of the spray pattern being close to the background levels for both the nozzles used.

A review of the literature (e.g. Downey *et al.*, 2004 and Giles *et al.*, 2004) together with discussions following the presentation of conference papers relating to the project work suggested that the risk of splash and secondary spray generation associated with large droplets hitting a large leaf target may be reduced by changing the physical properties of the spray liquid. Two series of experiments were conducted examining the effect of increasing liquid viscosity by adding Xanthan gum and methyl cellulose to the spray liquid both jointly and as separate components – these materials being specified in International Standards associated with evaluating crop sprayer performance. The results showed that using liquid with a relatively high viscosity (achieved by adding 0.5% Xanthan Gum) through the “Alternator” nozzle reduced the ability of this nozzle design to operate effectively resulting in

a much reduced spray pattern width. The addition of methyl cellulose (at circa 0.2%) gave a smaller increase in viscosity and enabled the nozzle to operate without a substantial reduction in pattern width. While increasing the viscosity made some difference to the risk of splash as assessed visually when spraying a white paper target with a coloured tracer dye, the improvement was relatively small and may not be practically and commercially relevant.

Work in conjunction with Monsanto (initially outside of the project) developed formulations of glyphosate that are less prone to drift when sprayed through conventional pressure nozzles. The commercial launch of this formulation enabled it to be used within the project and samples for the field experiments were supplied by Monsanto UK Ltd.

It was concluded that control of droplet trajectories and the minimizing of off-target and crop contamination due to both wind and splash effects could be achieved by using the nozzle designs proposed without modifications to the spray liquid properties. However, options to add components to a tank mix may need to be evaluated when commercial versions of the machines developed from this project work are being operated in a wide range of conditions.

2.3 Development of nozzles - laboratory scale

2.3.1 Nozzle cartridge design

The results from the work identifying spray generating options for combined spot and patch applications, described in Section 2.1 above, indicated that the full range of spray characteristics required could not be generated from a single nozzle design. A cartridge system (Fig. 15) was therefore developed that enabled the fitting of different spray tips to generate different spray characteristics for either spot or patch applications.

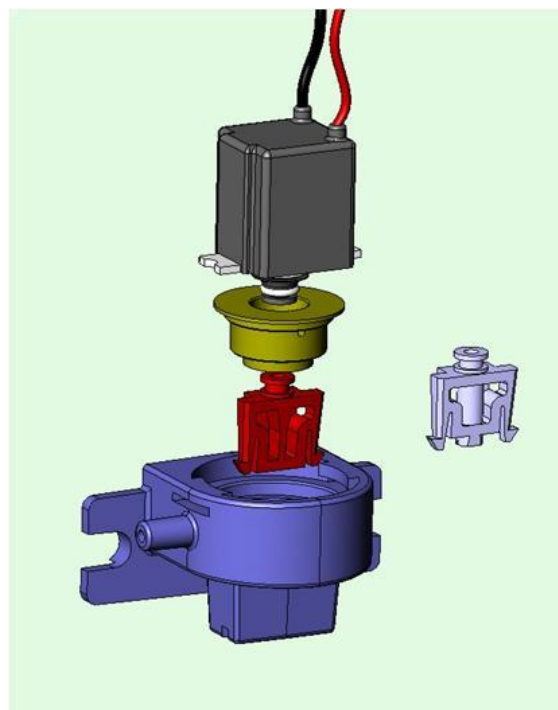

Figure 15. Cartridge arrangement for mounting the “Alternator” tip (red) and the “Even Spray” tip (light blue) together with the controlling solenoid.

Two spray tips were designed and fabricated:

- An “Alternator” tip creating very large droplets for spot treatment applications; and
- An “Even-spray” tip aimed at giving a spray quality on the fine/medium boundary that would be appropriate for applying herbicides to small weeds such as grasses at an early stage of growth.

The liquid flow into the cartridge was via a latched solenoid design that had been identified in earlier project work (Miller *et al.*, 2010b). This earlier study had shown that this design of solenoid would operate satisfactorily when using spray liquids that were complete solutions (e.g. glyphosate) but when emulsions were used, the valve tended to stick. This aspect of performance would be addressed in the current work – see Section 2.4.1 of this report.

2.3.2 Measurements of droplet size distributions

Measurements of the droplet size, velocity and spray volume distributions were made with a total of three different versions of the cartridge system (Fig.15) with both the “Alternator” and “Even-spray” tips produced for use in field trials. Measurements with the finalised versions were made with at least three nozzles of each design and sampling the whole of the spray at a distance of 250 mm below the orifice with a laser-based analyser.

Results for the final version of the “Alternator” design showed that performance was consistent with earlier versions of this nozzle with very large droplets generated and delivered with narrow spray fan angles. At a pressure of 0.75 bar, the mean droplet size, expressed as a VMD, was 1160 µm delivered with a mean spray angle of 15.3° with equivalent figures of 1139 µm and 17.0° at a pressure of 1.5 bar. A typical scan through the spray is shown in Fig. 16 indicating that the spray again tended to be bi-modal and with a substantial proportion of the spray in droplets >1000 µm in diameter.

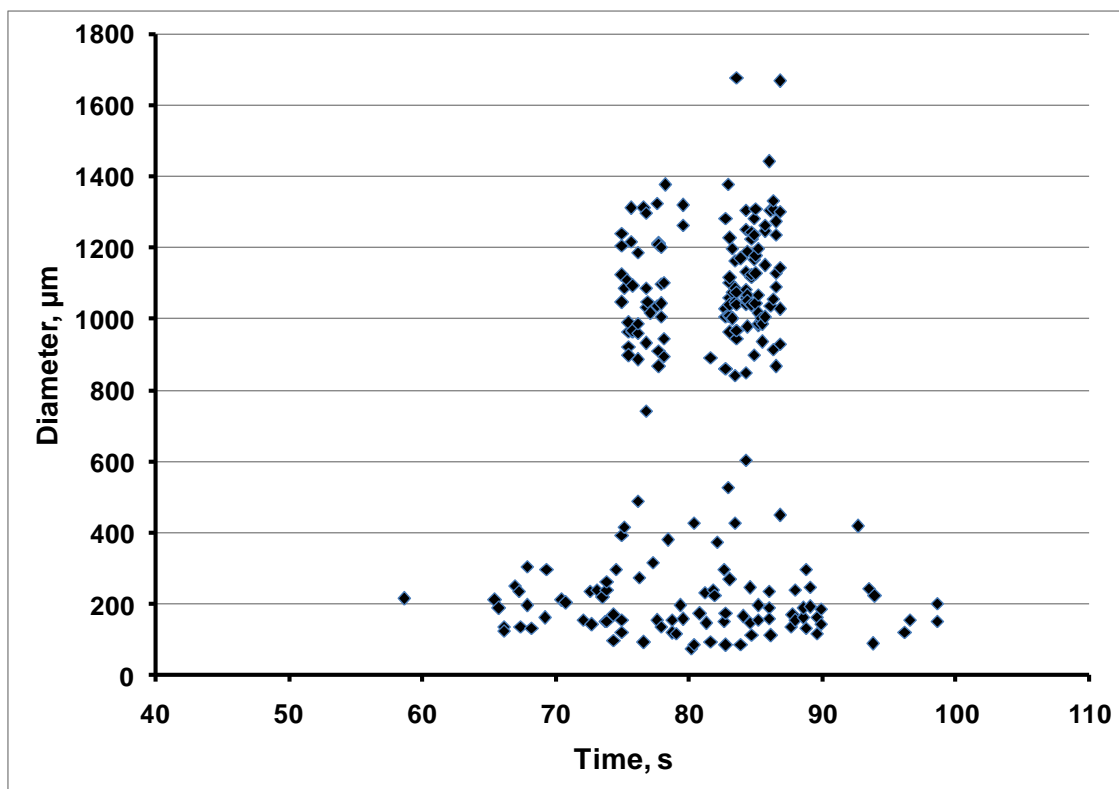

Figure 16. Measured droplet sizes on a scan through the spray from the “Alternator” nozzle operating at a pressure of 0.75 bar – measurement made 250 mm below the nozzle.

Results for the moulded version of the “Even-spray” nozzle gave a much smaller droplet size as expected with a mean VMD of 279 μm and a mean spray fan angle of 33.6° (Figs. 17 & 18). This spray fan angle was larger than that in the initial specification (25°) and the results shown in Figs. 17 and 18 also showed that the spray footprint was larger than expected particularly in the direction at right angles to the main fan pattern (Fig. 18). The edge of the spray fan pattern from the even-spray nozzle was not as sharply defined as with the “Alternator” design (see Figs. 15) but this was regarded as acceptable given that the even-spray nozzle was likely to be used in a patch (rather than spot) spray mode using selective rather than non-selective herbicides. The results also confirmed that the “Even-spray” nozzle was able to generate a fine spray at pressures greater than approximately 3.5 bar (see Fig. 19) and therefore would provide a nozzle suitable for the treatment of small weeds, particularly grass weeds, at an early stage of growth.

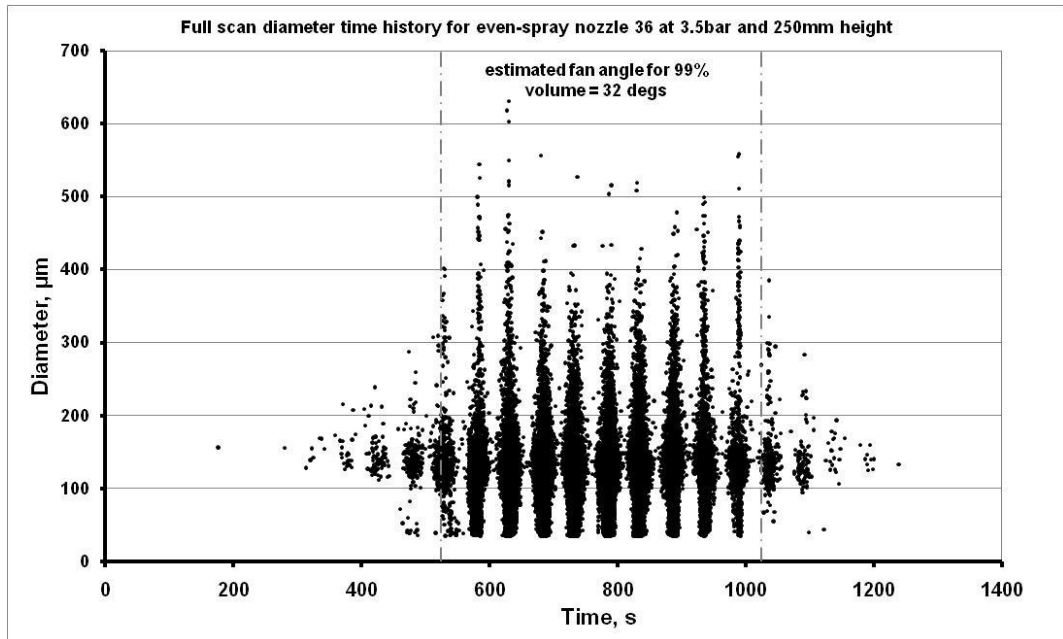

Figure 17. The droplet size distribution measured by scanning across the full spray pattern of the final design of the “Even-spray” nozzle operating at a pressure of 3.5 bar – sampling 250 mm below the nozzle.

The performance of the final versions of both the “Alternator” and the “Even-spray” nozzle was in line with expectations based on the initial studies with a prototype design manufactured by Hypro EU Ltd and detailed in Section 2.1 of this report.

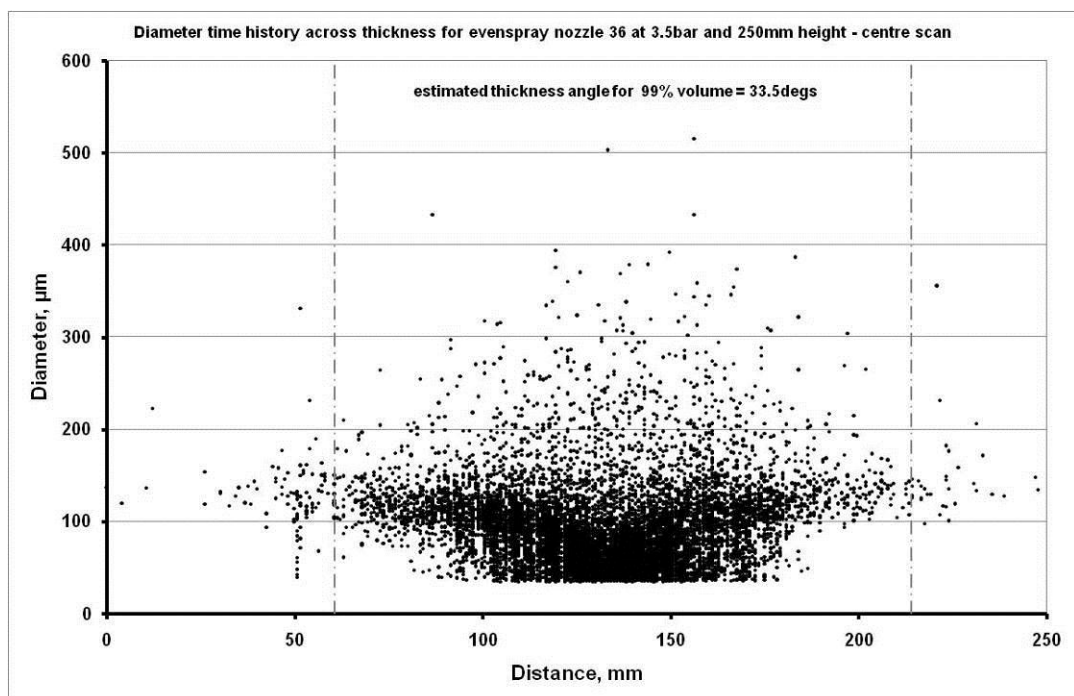

Figure 18. The droplet size distribution measured by scanning across the centre line of the spray pattern of the final design of the “Even-spray” nozzle operating at a pressure of 3.5 bar – sampling 250 mm below the nozzle.

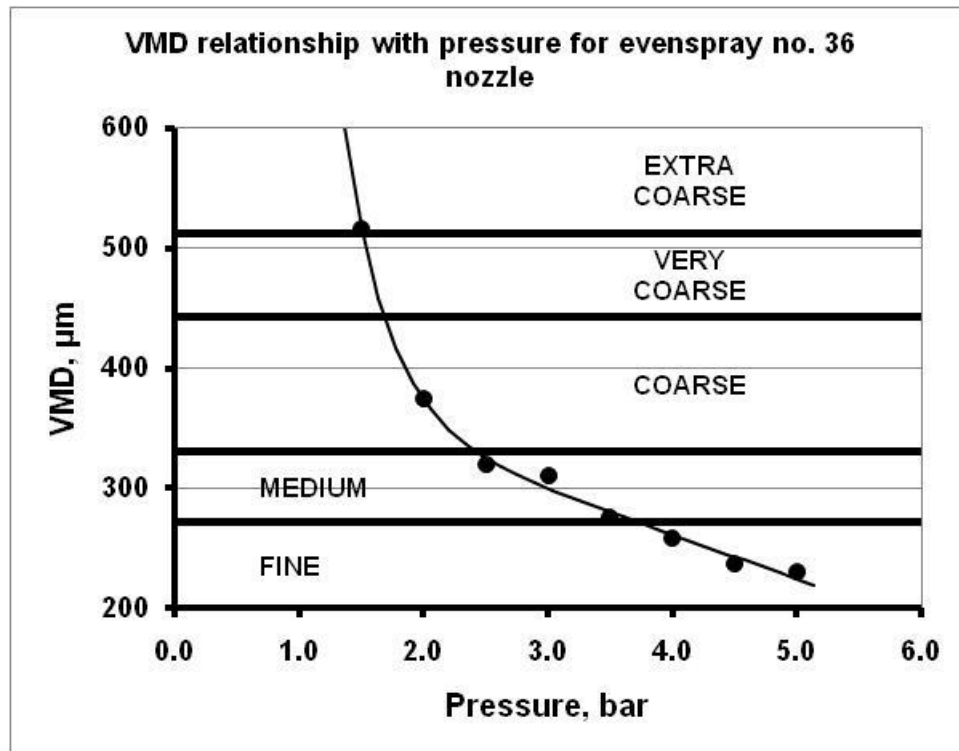

Figure 19. The variation in median droplet size as a function of pressure for the final design of the “Even-spray” nozzle.

2.4 Design a practical nozzle for field scale experiments

2.4.1 Nozzles and solenoids used in the first year of experimental work (2010 cropping season).

The original version of the experimental “Alternator” nozzles developed by Hypro EU Ltd for the previous project (i.e. before the cartridge system shown in Fig. 15 was developed as part of this project) were used in the first season of field experiments in this project as there was insufficient time to develop alternatives. Modifications were made to the method of driving the solenoid valves such that they were powered both on and off rather than relying on the latching mechanism – in this way the failures due to the solenoid valve remaining stuck open when operating with liquids that were not pure solutions referred to in section 2.3.1 above were eliminated pending the development of a revised solenoid design, but at the expense of an increase in electrical power consumption.

2.4.2 Revised nozzle, solenoid and filtration designs

Discussions with the manufacturer of the latching solenoid valves (A K Muller) led to the design of a revised solenoid valve for our application. This revision included changes to some of the materials and clearances to cope with herbicide formulations. Laboratory testing with a reference spray liquid that was representative of many herbicides formulated as emulsifiable concentrates and field experience in the 2012 season indicated that the design revisions had substantially improved reliability, though it is probably too early to say if these valves would be adequately reliable with the more aggressive formulations under commercial conditions. Operation with glyphosate, a solution, has always been reliable provided that levels of filtration are adequate.

A total of 60 nozzle and valve assemblies of the new cartridge design (see Section 2.3.1) were fabricated and installed on the experimental rig in preparation for field trials in the 2011 harvest season. Initial calibrations and field trials in the onion crop (see 2.5 below) showed that there was some inconsistency in nozzle performance. Close inspection showed that this was due to leakage between the cartridge housing and the nozzle insert with the “Alternator” design. These leakage problems were addressed by investigating the use of alternative plastics in the manufacture of both components. It was thought that use of softer materials would deform sufficiently to fill the small irregularities that are inevitable in the molding process. Experimentation showed that best results were obtained by retaining the relatively rigid material for the cartridge, but replacing the harder material with a softer plastic for the “Alternator” insert. A new batch of nozzles was manufactured for testing, installation and use in the 2012 cropping season.

The relatively small orifices found in the nozzles (0.5mm) and the solenoids (0.8mm) make the system more vulnerable to blockage by particles in the water than conventional spray systems for which a typical nozzle orifice is 1.0 mm in diameter. It is therefore necessary to operate the spot/band spray system with finer filters than is common practice. We fitted 200 mesh filters which are readily available and provided adequate protection. In longer term commercial use we anticipate that precautions will have to be taken against the buildup of lime scale.

2.5 Nozzle and experimental rig configurations

2.5.1 For the 2010 cropping season

Experiments were conducted in the onion crop in the 2010 cropping season in which the deposits on onion plants were compared with those on horizontal surfaces for both the experimental “Alternator” nozzle operating at a pressure of 1.0 bar and a conventional “Even Spray” “01” size nozzle with a spray angle of 25° and operating at a pressure of 3.0 bar. It was thought that the large droplets from the “Alternator nozzle” would be less well retained on the small onion plants than the smaller droplets from a more conventional nozzle design and the experiments sought to quantify the possible extent of this additional selectivity due to a droplet size effect.

Filter paper discs were laid on the surface of the soil and on a platform that corresponded to the top of the crop plants. These discs were positioned over the centre of the crop row (see Fig. 20) and were sprayed by driving the rig down the crop row at a speed of 4.0 km/h using nozzles also positioned over the crop row. Both nozzles sprayed a solution of a tracer dye (“Green S” – Sensient Colours Ltd) at 0.1%. Deposits were recovered from the centre sections of the filter papers corresponding to the sprayed strip and from samples of 25 onion plants that were taken from within the treated row. Three replicates of all samples were taken. The form of the deposit on the filter papers clearly showed the oscillating action of the “Alternator” nozzle (Fig. 21) with a more conventional pattern from the “Even Spray” nozzle as expected.



Figure 20. Experimental layout for sampling deposits on horizontal surfaces and onion plants in field conditions

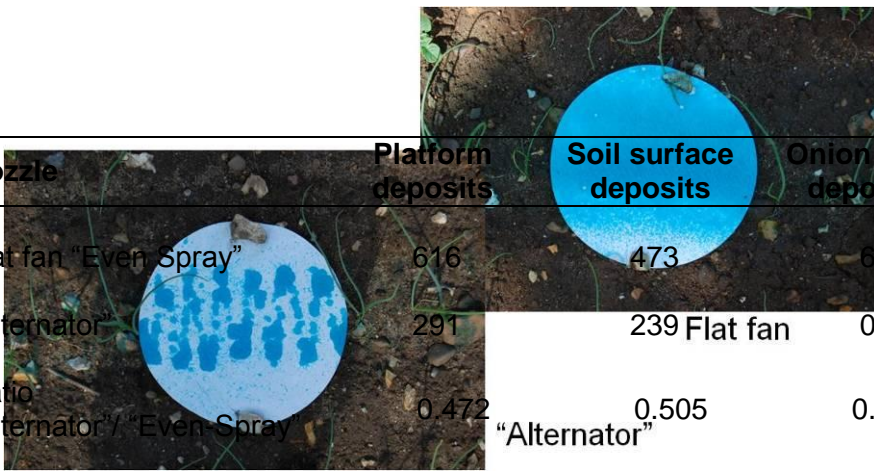

Nozzle	Platform deposits	Soil surface deposits	Onion plant deposits
Flat fan "Even Spray"	616	473	6.35
"Alternator"	291	239 Flat fan	0.87
Ratio "Alternator" / "Even Spray"	0.472	0.505 "Alternator"	0.137

Figure 21. Deposits on the horizontal collectors sprayed with the two nozzles used in the study

Deposits measured on the filter papers and onion plants are summarized in Table 2. Because the flow rates and patterns from the two nozzle designs were not directly comparable, deposits on both collector types have been expressed as a ratio. If both surfaces had comparable collection characteristics then this ratio should be a constant. Results in Table 2 show reasonable agreement in the deposit ratios for the paper collectors at the two positions (0.472 and 0.505) but with a much lower ratio for the onion plant deposits. This result indicates that deposits of the coarser spray from the "Alternator" nozzle were approximately one third of those of the finer spray and this difference in deposit on the onion plants could also be seen visually (Fig. 22).

Table 2. Measured deposits in μL on filter papers mounted on a platform and at ground level and on sampled onion plants



Figure 22. Examples of spray deposits on onion plants of the two spray types.

(a) left – from the “Alternator” nozzle.

(b) right – from the “Even Spray” nozzle.

2.5.2 For the 2011 cropping season

Calibration of the new nozzle design fitted to the experimental rig showed that a number of the units were not operating as expected and the poor performance was identified as being due to leakage between the “Alternator” insert and the main nozzle body. Initial laboratory experiments had suggested that this characteristic would be transitory and would correct itself as the nozzle bedded in with use. This did not happen quickly with a number of units installed on the booms of the experimental field rig. Accumulations of liquid gathered around the nozzle orifice influencing both spray pattern and flow stability. The nozzles that were seen to be most troublesome were removed during the initial field trials and the nozzles re-arranged such that two booms used the new design and one boom used the design from the earlier project (Fig. 23).



Figure 23. The experimental rig as set up for the field trials in the onion crop in the 2011 cropping season. Note the new nozzle/valve assembly design (in orange) fitted to the two booms on the far side of the machine and nozzle/valve assemblies from the previous project (in blue) fitted to the nearside boom.

The time resolution of the nozzle control electronics was increased so that the controller worked in 15 ms time steps rather than the 30 ms used previously. For the machine operating at 5.0 km/h (1.4 m/s) this equates to an improvement of spatial resolution from 42.0 mm to 21.0 mm.

2.5.3 For the 2012 cropping season

For spot and patch spraying in 2012 the machine was fitted with revised cartridge nozzles across the full 6.0 m width. For spot applications the “Alternator” tips were used and for patch spraying these nozzles were exchanged for the “Even-Spray” version. The volume of liquid applied during patch spraying is substantially higher than that used during spot spraying. It was therefore necessary to introduce a new rear mounted 500L tank and a conventional electrically driven spray pump to deliver the required maximum flow rate of 17.5 L/min

2.6 Refine detection algorithms

2.6.1 Refined individual weed tracking for improved spot spray accuracy

In previous work, implement motion through sequences of images has been tracked using a Kalman filter providing a high degree of robustness where data may be poor, due to poor crop stands, or weed infestation. To date, individual weeds have been identified within each image and a spray map created based on position relative to the bank of nozzles. As the same weeds appear several times in a sequence of images it has been necessary to implement an algorithm to vary the spray map as weeds apparently change through an image sequence. Whilst this approach yielded good results, there was some potential to improve accuracy especially with taller weeds that exhibit some apparent motion within an image due to perspective changes.

In this work, weeds defined by convex polygons have been individually tracked in the Kalman filter enabling a more accurate picture of true weed shape and position to be built up. This also enables spray map generation to be deferred to the point at which the best estimates are available. This refinement included provision for cases where two or more weeds seen at the top of an image merge to form a single target by the time they are viewed for the last time. Conversely the case where what is perceived as one weed at the top of the image appears as two separate targets at the bottom was also handled. The algorithm has been interfaced with a treatment map. This new approach to weed tracking underwent basic testing on sequences of stored images and an artificial crop prior to field testing.

In 2011 field trials the system performed well, but it was noted that more of the area of large broadleaf weeds was being sprayed than might have been expected. Investigation showed was due to a smearing effect where the convex polygons placed around plants seen multiple times grew with time. Close inspection showed that there were several reasons for this. The simplest was that the cameras were vibrating sufficiently to cause jitter in plant position in sequences of images. The solution to this was mechanical stiffening of the camera poles. The most significant issue related to the model used to represent radial camera lens distortion. This proved insufficiently accurate at the edges of an image so that there could be a significant error when features were transformed from image into ground coordinates. This in turn caused difficulties in tracking features from one frame to another. An improved radial distortion model was implemented and performance improved.

2.6.2 Detection of patches of smaller weeds

In previous work we showed that it was possible to estimate overall weed density in widely spaced (25 cm) cereal crops by measuring a green index in the inter-row zone prior to

canopy closure (Hague et al., 2006). The earlier work generated weed maps from stored image sequences, but made no on-the-spot spray treatment decisions. In this project we have developed an algorithm to conduct weed patch detection in vegetables using the same technique and linked it to real time treatment. This work was first tested on sequences of stored images and underwent field testing in 2011 and 2012.

Figure 24 illustrates how the algorithm overlays green lines onto crop rows and places rectangles with blue borders inter-row defining the inter-row sample area. It is the number of pixels within these boxes above a pre-defined greenness threshold that determines the weed density in that image. Pixel size in the experimental system equated to approximately 5mm square in ground coordinates. For regions with a large number of small weeds a high proportion of pixels in the sample area will therefore cover a combination of both plant and background. Consequently the proportion of pixels adjudged to contain weeds will be sensitive to the choice of threshold. It is therefore important that the threshold is fixed and that the camera produces images that are of consistent hue under all lighting conditions. The system can be made less sensitive to threshold by increasing imager resolution, i.e. reducing pixel size, but there will always be some sensitivity to threshold due to this factor. The cameras used in the experimental work did exhibit some variation in hue between devices and in some cases within an image. These variations were most marked as light intensity varied outside the range that could be compensated for using the camera's electronic shutter range. For this reason it is anticipated that the budget cameras used here would be replaced by more sophisticated devices in future work.

The length of the rectangular inter-row sampling areas was chosen so that at maximum operating speed all of the inter-row region would be viewed at least once. The decision to turn an individual nozzle on was made on the basis of an interpolated average weed density in the surrounding region. This average was calculated by a linear center weighted interpolation of weed density over an area defined by a user definable patch size. That size was defined as the radius at which the weighting was reduced to zero. For our experimental work in 2012 patch size was set at 0.5m. In order to prevent excessively large data sets being built up when the machine was stationary, or travelling at low speed, only sample areas that did not overlap were used to calculate average weed density at each nozzle.

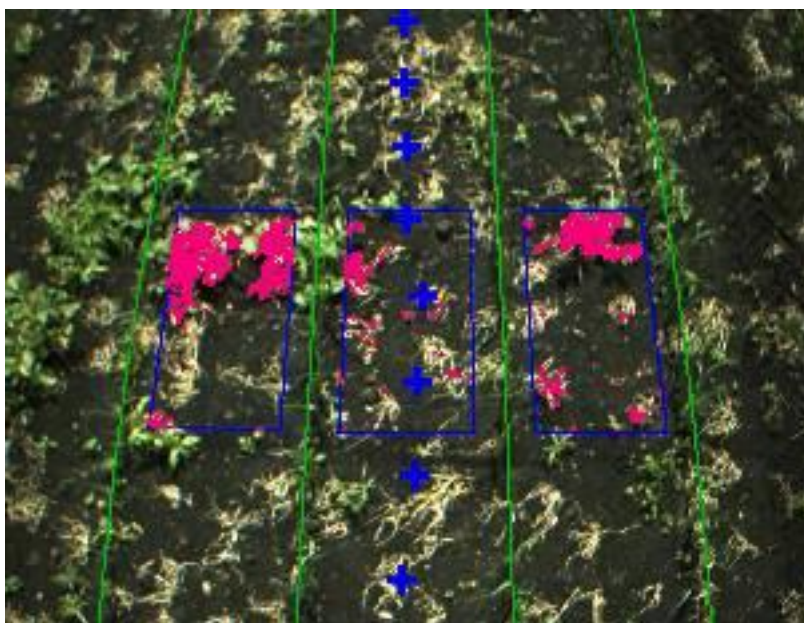

Figure 24. Inter-row weed patch detection zones outlined in blue with areas above the “greenness threshold highlighted in pink

Whilst the primary focus of this project was on real time control of spray nozzles it is likely that in commercial use a grower would also wish to log the spatial distribution of weeds and herbicide application. To investigate some of the practical aspects of this process the experimental machine was fitted with a dual frequency GPS receiver so that data on weed density or nozzle on/off status could be logged against position. In our experimental work weed density in each non-overlapping inter-row sample area was logged with the corresponding GPS tractor position and a lateral and forward offset. These were post processed using a Kriging algorithm to produce an field weed map. Figure 25 shows a weed map generated in this way during the 2012 leek field trials. As the trials was only a preliminary one there was no ground truth data recorded for performance verification.

2.6.3 Investigate height based discrimination, primarily for weed beet

Two options for weed detection through height discrimination were given a preliminary evaluation. The first was a relatively simple technique based on a low cost optical range sensor (Sharp GP2Y0AO2YK). The second was based on stereo computer vision in which disparity between two images taken from cameras set a few centimetres apart can be used to calculate range.

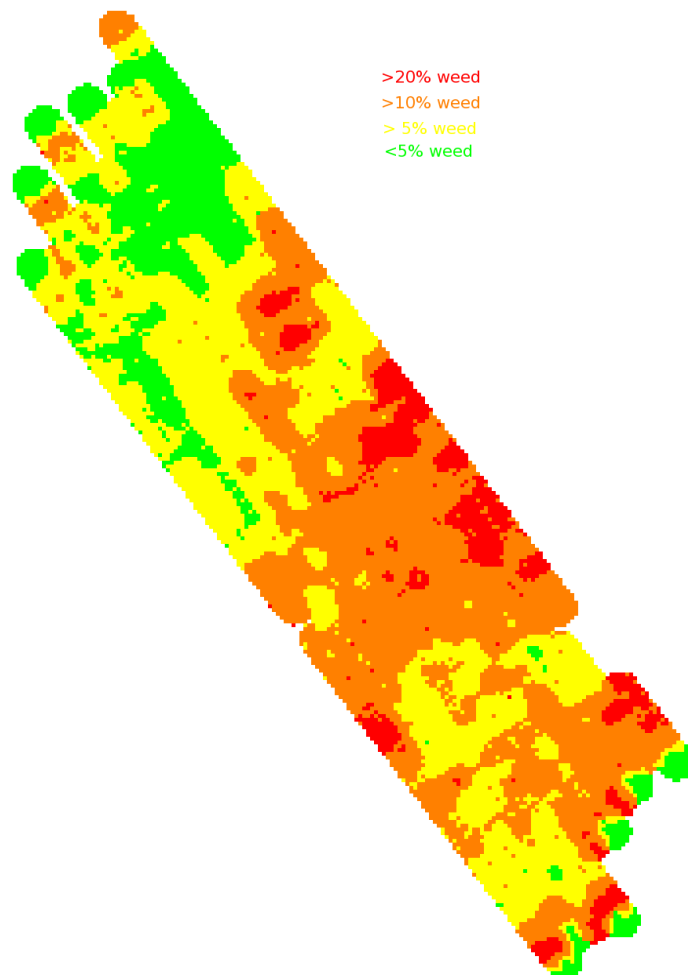

Figure 25. Weed map in a field of commercial leeks created using the weed patch detection algorithm

The Sharp optical range sensor use triangulation of a modulated beam of IR light reflected back from a target. A small linear CCD array included within the package detects the reflected beam and its position along that array is proportional to range. If there is no object in range, the light is not reflected and the reading shows no object. Modulating the beam improves immunity to interference from ambient light and the frequency of the light (IR) is readily reflected by plant material. The output is voltage that can be converted to range by calibration.

We anticipated some reliability issues with this technique under field conditions, but hoped that it might provide an adequate method of testing the effectiveness of spot spraying from above. Laboratory testing did demonstrate that weeds could be detected using the system as shown in Figure 26. However, the reliable range was limited to just over 1.0 m making the arrangement difficult to implement on a field rig. This method was not pursued further.

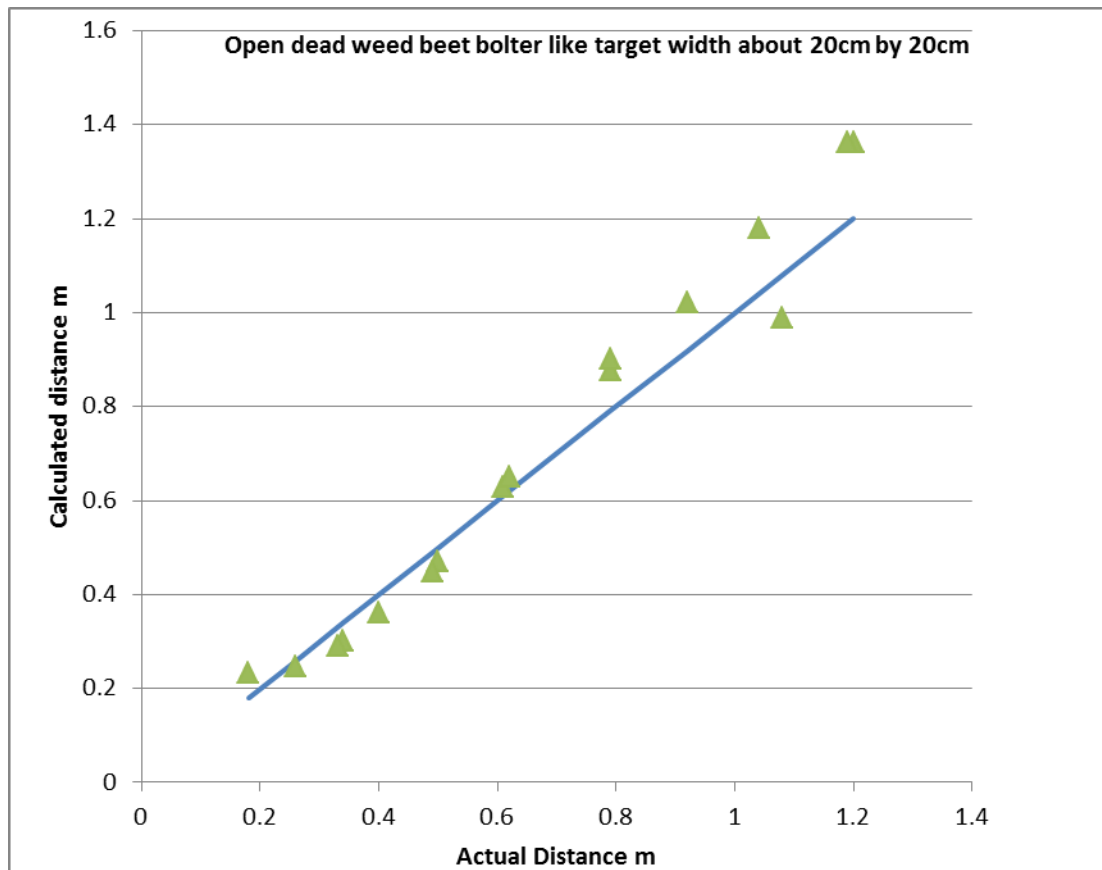

Figure 26. Example of laboratory range test using a Sharp optical range sensor with sensor range readings shown as green triangles and a ideal 1:1 relationship shown as a blue line.

The main focus of our work on detection through height detection therefore focused on stereo vision. However, this is a challenging environment for stereo vision due to the lack of clear cut geometric features from which to deduce disparity.

We constructed of a stereo camera comprising two high resolution (1024 by 768) imagers placed 12.0 cm apart that could be synchronized under control of a computer (Figure 27). This was used to take static stereo pair images of weed beet and bolters in a crop of sugar beet with a view to investigating the feasibility of detecting these types of weeds by height differential. Software was written to post-process these images and generate depth images. Application of this software to these image pair did show some promise, but the stereo analysis algorithms would require further refinement if the technique is to progress to a practical sensing technique. In Figure 28 the stereo image illustrates the general reduction in brightness from bottom to top of the image due to camera poise. The brighter patch in the center of the image is due to a tall weed beet plant. The black areas are undefined and would be disregarded in any weed beet detection algorithm.



Figure 27. Stereo camera specially constructed to take stereo images of weed beet

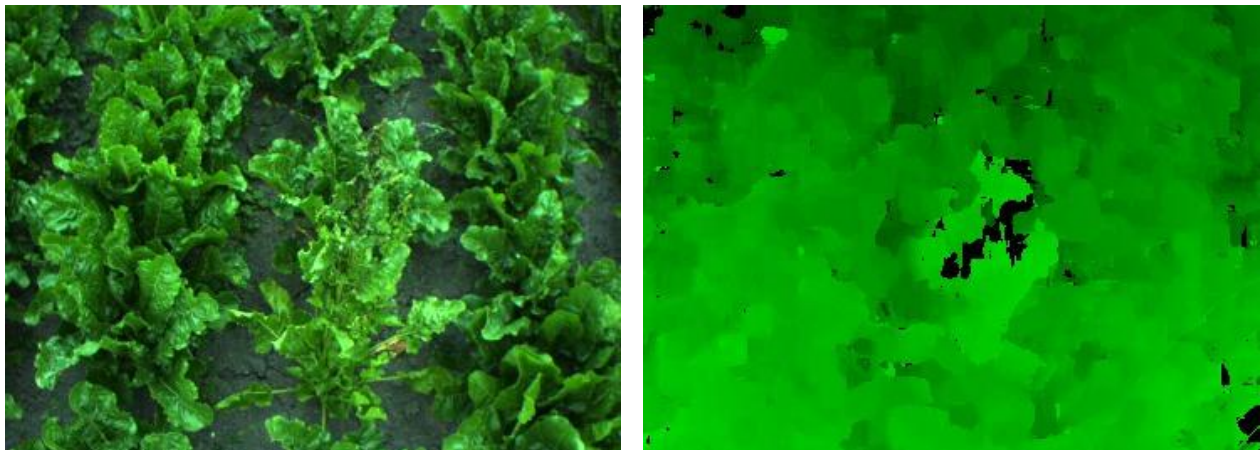

Figure 28. Single frame from a pair of stereo images (left) and a stereo image (right) where brightness decreases with increasing range.

Whilst this study has shown that it might be possible to detect weed beet using this technique it is likely to be a relatively expensive one at current technology prices. It is necessary to use two relatively high quality cameras to view only a 2.0 m working width. A 6.0 m machine would therefore require 3 pairs of cameras and substantial computing power for image processing.

2.7 Field trials in a range of crops

2.7.1 In the onion crop

An initial experiment in onions was conducted on 25th May 2010 in which a treatment comprising 500 mL/ha of fluroxpyr (as “Starane”) and 500 mL/ha of ioxynil (as “Totril”) were applied to detected volunteer potatoes in nominally 300 L/ha of water. The experimental rig travelled at a speed of 4.0 km/h and used a two camera configuration to treat 12 rows spaced at 0.17 m (1.5 beds) per pass (see Figure 29).



Figure 29. Experimental rig as configured for work in the onion crop in May 2010

Results showed levels of control that were comparable with those from an overall spray application although some small volunteer potatoes plants were missed by the detection routine probably because they were below the minimum size (3.0 cm) threshold at the time of treatment. Detection levels were estimated at between 90 and 95%. As expected, given that a selective herbicide mixture was being applied, there was no evidence of substantial crop damage.

The levels of control when using different formulations applied as a spot spray to volunteer potatoes was also examined in the onion crop in treatments applied on 28th May 2010. The experimental rig configuration was as used in the initial trial and shown in Figure 29. The following tank mixes were applied in nominally 300 L/ha of water:

- (a) Fluroxpyr (as “Starane”) + ioxynil (as “Totril”) both at 500 mL/ha;

- (b) As (a) above + bentazone (as “Basagran”) at 500 g/ha;
- (c) Flumioxazine (as “Digital”) at 100 mL/ha.

Treatments were applied when travelling at 4.0 km/h with the system set to treat a minimum target size of 3.0 cm and apply spray to 75% of the target area. For each treatment, four random blocks each containing 25 volunteer plants were marked (100 plants in total) and were assessed and scored visually at 3 and 16 DAT.

The results shown in Figures 30 to 32 indicated that the treatment based on flumioxazine was more effective in controlling the volunteer potatoes and also acted more rapidly than the fluoxypyr + ioxynil mixture that is often sprayed overall in repeat applications to give control of volunteer potatoes in the onion crop.

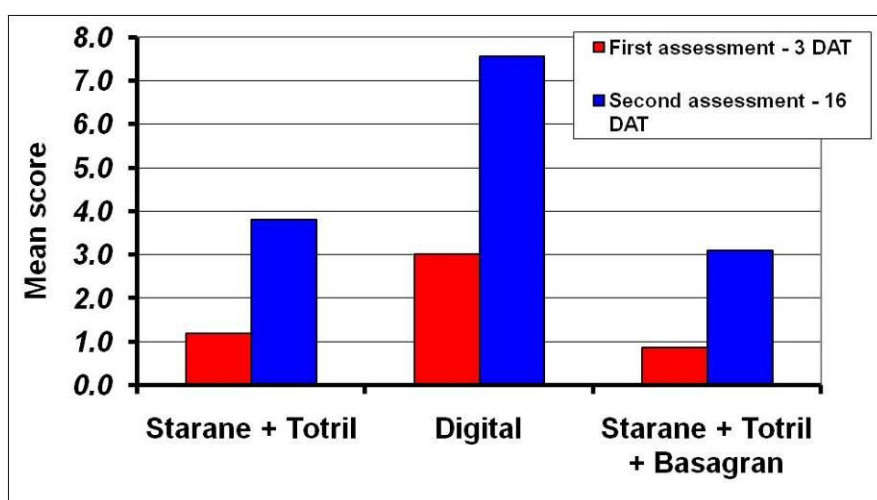

Figure 30. Mean scores for the control of volunteer potatoes treated by spot spraying different formulations in the 2010 cropping season as assessed visually at 3 and 16 DAT.



Starane + Totril



Digital

Figure 31. Volunteer potatoes 3 DAT – spot sprayed in the 2010 cropping season with fluoxypyr + ioxynyl (left) and flumioxazine (right).



Starane + Totril



Digital

Figure 32. Volunteer potatoes 16 DAT – spot sprayed in the 2010 cropping season with fluoxypyr + ioxynyl (left) and flumioxazine (right).

In the 2011 cropping season assessments were made of the levels of control achieved by the system when using both selective (Flumioxazin as Digital at 100 mL/ha) and non-selective (glyphosate at 4.0 L/ha) herbicides. Levels of crop contamination around treated volunteer potatoes were also quantified. Treated crops were assessed visually 6 days after treatment. The results showed detection levels of 95.4% of volunteer potatoes and much higher levels of kill (circa 95%) with a total herbicide than with a selective herbicide (see Figs. 33 & 34). The response to the selective herbicide was noticeably less pronounced than in the previous year (2010) and this may have related to the dry growing conditions leading to higher levels of leaf wax.



Figure 33. A typical volunteer potato in an onion crop spot treated with glyphosate in the 2011 cropping season and assessed after 13 days.



Figure 34. A typical volunteer potato in an onion crop spot treated with flumioxazin (as Digital) in the 2011 cropping season and assessed after 13 days

Measurements of crop contamination were made by placing a 300 mm diameter stainless steel ring around volunteer potato plants that had been spot sprayed with a tracer dye solution (nominally 1.0% “Green S”). All plants (volunteer potatoes and onions) within the ring were then carefully cut and sorted into bags containing either potato or onion foliage. Bags were then returned to the laboratory, weighed and the quantity of original spray liquid retained on the plants determined by washing in a known volume of de-ionised water and using spectrophotometric techniques calibrated with a reference dye sample taken from the spray nozzles at the time of treatment. A total of 25 potato plants were sampled. Results from this work showed that deposits on crop plants within 150 mm of a treated volunteer potato were, on average, an order of magnitude less than on the target weed (Fig. 35) at $0.56 \pm 0.36 \mu\text{L/g}$ compared with $10.56 \pm 3.23 \mu\text{L/g}$ plant weight on the potatoes.

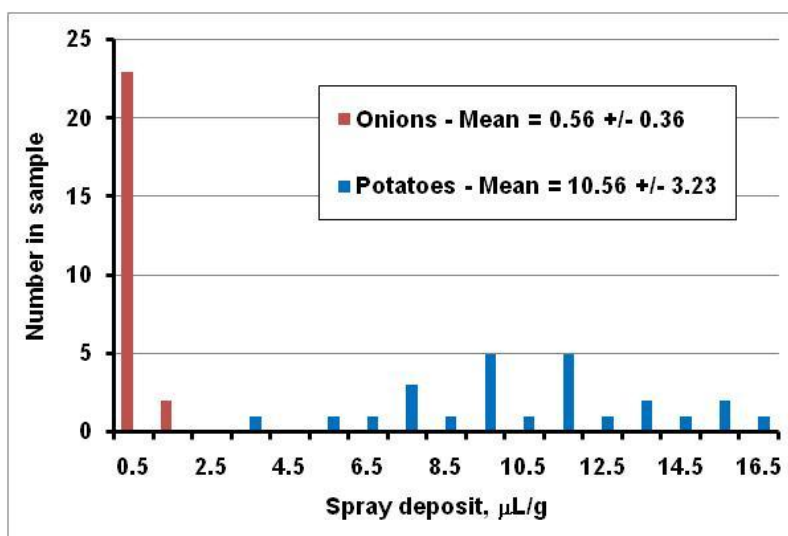

Figure 35. The distribution of measured deposits on spot treated volunteer potatoes and surrounding onion plants.

Previous studies (Miller *et al.*, 2010) in which glyphosate residues were measured in onions that were visually assessed as having been influenced by the glyphosate spot applied to neighbouring weeds and volunteer potatoes showed that these were below the levels of detection in any crop plant that was close to being of a harvestable and marketable size.

It can therefore be concluded from this and previous project work that:

- Spot treatment using the systems developed in the two projects are capable of detecting in the order of 95% of large weeds such as volunteer potatoes at a defined timing;
- Levels of weed control of up to 95% can be obtained by the spot application of glyphosate and that using a high dose of glyphosate on a treated weed/spot results in a relatively rapid weed kill with commercially acceptable levels of crop damage;
- Using selective herbicides eliminates crop damage but weed kill is usually much slower and may not be complete from a single application;
- Spray deposits on target weed plants are at least an order of magnitude greater than on crop plants within or adjacent to the treated spot;
- Residue levels in contaminated crop plants are below the limits of detection for any crop reaching a harvestable/marketable size.

2.7.2 *In the leek crop*

The experimental rig was used in a crop of leeks on 15th June 2010 spot spraying a mixture of fluoxypyr (as “Starane”) and clopyralid (as “Shield”) both at a rate of 500 mL/ha in nominally 300 L/ha of water to control volunteer potatoes and thistle. A 3 camera configuration was used with 26 nozzles treating 6 rows spaced at 0.5 m (1½ beds per pass) at a speed of 4.0 km/h. The crop was relatively small and with some uneven emergence due to dry conditions and this necessitated using a relatively low forward looking camera angle so as to identify the crop rows. Treated plants were identified with stakes and were assessed to determine levels of control at 8 DAT. The treatments were seen visually to be effective at the time of application with spray being well directed to the target plants. However, assessment of the levels of control achieved was confounded by previous treatments applied to control both volunteer potatoes and thistles but was judged subjectively to have been equivalent to a further overall spray application with the tank mix applied in spots.

In the 2011 cropping season, treatments were applied based on an aggressive tank mix of selective herbicides (Starane at 0.5 L/ha + Shield at 1.0 L/ha + Linuron at 1.0 L/ha) and a non-selective herbicide (glyphosate at 4.0 L/ha) to a crop having a moderate to heavy weed infestation (Fig. 36.). The weeds were volunteer potatoes with some redshank and thistle. Treated crops were assessed visually at both 8 and 15 days after treatment. The results with the selective tank mix gave levels of control that were comparable with overall spraying (Fig. 37.) and with no evidence of crop damage. Weed kill was more rapid with glyphosate (Fig. 38.). Control was estimated at circa 90% and there was very little evidence of crop damage.



Figure 36. Spot spraying of volunteer potatoes in a leek crop - June 2011



Figure 37. Control of volunteer potatoes achieved by spot spraying a selective herbicide mixture and assessed at 15 days



Figure 38. Control of volunteer potatoes achieved by spot spraying a non-selective herbicide (glyphosate) and assessed at 15 days

In the 2012 cropping season, spot applications of both a tracer dye and glyphosate were made to two fields with the objectives of monitoring levels of weed detection/control, deposits on weed and neighbouring crop plants and any residues within crop plants adjacent to treated spots – see Figure 39.



Figure 39. Application to treat mugwort (*Artemisia Vulgaris*) by spot treatment in July 2012

The fields treated were as follows:

- **Field 1** - The crop was treated on 20th July by spot spraying wild mint using a field dose of 4.0 L/ha of glyphosate (as Roundup Flex) in 200 L/ha of water on treated spots. Spray was applied to 40% of the detected weed area when travelling at a forward speed of 4.0 km/h. Rain commenced approximately 1 hour after treatment;
- **Field 2** - The crop was treated on 23rd July by spot spraying mugwort (*Artemisia Vulgaris*) using a field dose of 4.0 L/ha of glyphosate (as Roundup Flex) in 200 L/ha of water on treated spots. Spray was applied to 40% of the detected weed area when spraying glyphosate and 40 and 80% of the detected weed area when spraying a tracer dye. The forward speed was 4.0 km/h for all treatments. The period following treatment was dry.

In each field, counts were made over four batches of nominally 100 m length of row of the total number of weed plants and the number of weed plants that had been dosed with the tracer dye. Results from these counts indicated that a mean detection rate of 90.1% had been achieved with most missed weeds being within the crop row and relatively small.

For each of the areas treated with the tracer dye solution using the two machine settings in Field 2, 25 weed plants were identified at random and these plants together with any crop plants within a 150 mm radius of the centre of the treated plant, identified using a stainless steel sampling ring, were cut, sorted into plastic bags, labeled and returned to the laboratory for analysis. In the laboratory, each bag was weighed and the quantity of dye on both weed and crop plants was determined by washing in a known volume of de-ionised water and determining the amount of original spray liquid using spectrophotometry calibrated with samples of the liquid taken from the spray tank. The results plotted in Figure 40 show that:

- Deposits on the weed plants were approximately two orders of magnitude greater than on the crop plants;
- Deposits on weed plants when 40% of the detected area was sprayed were about half those when 80% of the detected weed area was sprayed as expected and with a similar proportionate increase in the deposits on crop plants.

In each of the two fields, 20 weed plants were identified with crops plants adjacent to then with a mix of weeds in and between the crop rows and marked with a stake. On the 17th September, crop plants from immediately around the stake positions were cut, bagged and returned to the laboratory for weighing and sorting prior to being sent for analysis to determine glyphosate residues. Results of the measured residues are given in Table 3.

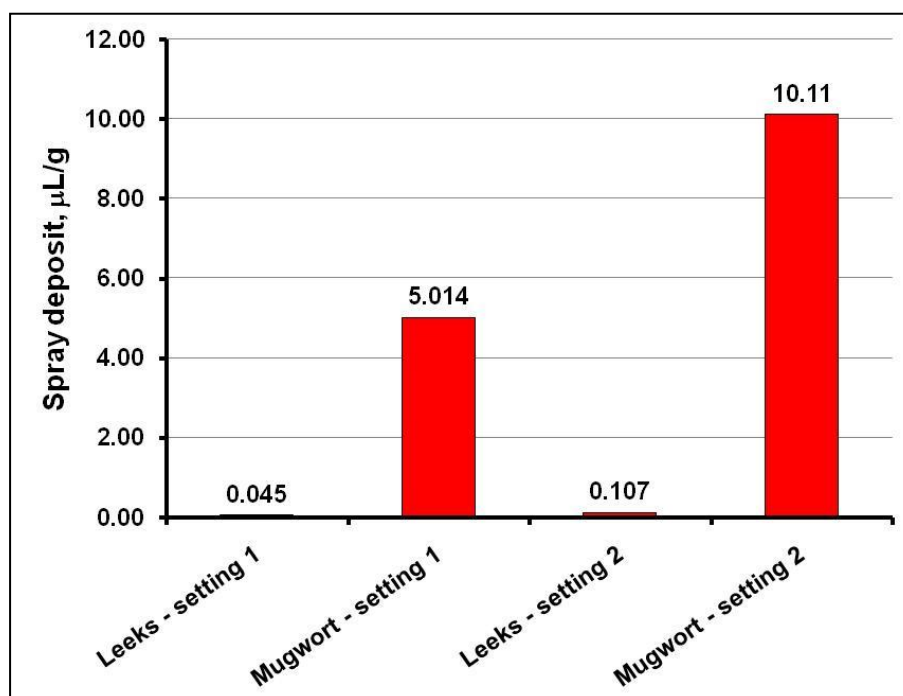

Figure 40. Distribution of measured weed and crop deposits when operating to spot treat mugwort in a leek crop.

Table 3. Residue levels determined on leek crop plants close to treated weeds.

Sample	Field	No. of plants	Total Weight, g	Residue level	Comments
1	2	2	487.5	Below detection	
2	2	3	342.5	Below detection	
3	2	3	261.0	Below detection	
4	2	2	349.0	Below detection	
5	2	4	276.3	Below detection	
6	2	6	307.6	Below detection	
7	2	3	325.5	Below detection	
8	2	2	381.6	Below detection	
9	2	3	450.1	Below detection	
10	2	2	187.0	Below detection	
11	2	7	152.2	Below detection	Small plants - unmarketable
12	1	11	210.0	Residue detected, below quantification	Small plants - unmarketable

The results in Table 3 show that no residues were detected in the plants recovered from Field 2 and those detected in plants recovered from Field 1 were below the level of quantification and were in small unmarketable plants only.

For the leek crop it can be concluded that:

- High percentages (circa 95%) of large weeds such as volunteer potatoes, mugwort and wild mint can be detected in leek crops and controlled by the spot application of glyphosate with acceptable levels of crop damage.
- The spot application of selective herbicides and herbicide mixtures enables the use of products, mixtures and doses that would not be appropriate for overall application because of the risk of crop damage. The use of such approaches gives a slower weed kill than that achieved with high doses of glyphosate on the spots but minimises the risk of crop damage.
- Spray deposits on the crop plants adjacent to treated spots are at least an order of magnitude less than on the weeds and measurements in one field condition gave differences of two orders of magnitude.
- No detectable residues were found in crop plants growing adjacent to weeds at the time of treatment when residues were assessed prior to crop harvest.

2.7.3 In the sugar beet crop.

On the 4th June 2010 the experimental rig was set up with a single camera arrangement and nozzles mounted to treat four rows 0.5 m apart in a single pass. The condition of the crop (leaves almost meeting in the row) and the weed populations (very low populations of large weeds between or within crop rows) meant that it was not feasible to spot spray in this crop with a total herbicide and no agronomic results were obtained. A separate camera was mounted on the rig and used to collect further images that were used in the development of the detection algorithms.

Experiments conducted in the 2011 harvest season had the objectives of testing the new nozzle systems, refining the detection algorithms and examining inter-row spray applications of a non-selective herbicide. Some problems with nozzle leakage and the switching of nozzles were experienced. These were initially thought to relate to aspects of water quality used in the preparation of the total herbicide (glyphosate) mixture but were subsequently traced to leakage in the nozzle components and features of the control algorithm. Weed pressures were very low and although useful rig performance assessments were completed, no agronomic assessments were made.

Experiments were also conducted in which sprays from a hand-held pulsed nozzle system were directed at the base of weed beet simulating the application of spray to the weed beet

that had been detected and pushed forward by a rubbing bar at a height of 350 mm. Spray pulses of 0.02 seconds were used to drive a 12 V d.c. solenoid positioned immediately upstream of an “015” 25° even-spray nozzle that was operated at a pressure of 2.0 bar. The spray liquid was a 2.0% solution of glyphosate (as Roundup Flex) and the number of pulses applied to each plant was varied between one and six depending on the size (maximum plant diameter above the ground) of the weed beet. The nozzle was positioned approximately 250 mm above the base of the weed. The size and leaf characteristics of each treated weed beet were also recorded. Assessments of the effects of the spray application were made 7 days after treatment by visual scoring and taking photographic records. Results from these experiments were inconsistent – see Figure 41. Some of the weed beet showed significant effects due to the spray application and it was likely that these would die. Other plants showed small and in some cases insignificant effects. There was no correlation between the level of control and weed size or the quantity of leaf at the base of the plant. Some plants were bent over by the simulated rubbing bar action and in some cases these plants remained mainly horizontal but continued to grow.

It was concluded that the treatment of weed beet, even once detected posed substantial problems particularly given the variable responses seen in these experiments. Although no crop damage was observed, the size of weed beet when they can be reliably detected means that targeting effective treatments that will minimise crop damage will be difficult.

In the 2012 cropping season experiments were conducted to examine the spot spraying of volunteer potatoes in a beet crop and to examine the patch treatment of weeds within the crop. Two tramlines approximately 500 m long were left unsprayed in a crop established on a medium loam soil with high chalk content. Experiments to spot spray volunteer potatoes used a full boom fitted with the finalised design of “Alternator” nozzles (Figure 42) and applied glyphosate at 4.0 L/ha in 250 L/ha of water when travelling at 4.0 km/h.



(a) Before treatment



(a) After treatment – some yellowing but plant likely to survive



(b) Before treatment



(b) After treatment – plant likely to die

Figure 41. Results of experiments with weed beet.



Figure 42. Experimental machine operating to spot spray volunteer potatoes in the sugar beet crop in May 2012.

The machine was operated with minimum weed size thresholds that were varied between 6.0 and 8.0 cm but the basis for detection was hampered by the small size of many of the volunteer potatoes compared with the beet plants – see Figure 43. Assessments of the level of control were made by counting plants in a total of 8 100 m lengths of row and gave results indicating that levels of control varied between 50 and 78%. Most of the plants that were missed were below or close to the size threshold with higher levels of control noted when the size threshold setting was the smallest. Small volunteer potato plants within the crop row were particularly likely to be missed. Little damage to the beet was recorded except in one row where high damage was traced to a failure in one of the controlling solenoid valves.

The patch spraying algorithm was tested by spraying a tank mix comprising the following components at nominally 100 L/ha:

- An emulsifiable concentrate containing phenmedipham and desmedipham (as “Betanal Turbo” at 500 mL/ha;
- A suspo-emulsion containing phenmedipham (as “Mandolin Flow”) at 500 mL/ha;
- A suspension concentrate containing lenacil (as “Venzar Flowable”) at 250 mL/ha.

The nozzle system was initially calibrated and set-up for inter-row spraying using water. The operation with the tank mix substantially increased the spray fan angle from the “Even-Spray” nozzles when compared with spraying water and this had implications for the width

of the treated band between the rows and the application rate/forward speed. It was also noted that the spray was not always symmetrical about the nozzle position – see Figure 44. An application was made when travelling at a forward speed of 6.0 km/h and the results indicated that the levels of weed control in the inter-row region within the patch was comparable with that achieved by the overall spraying of selective herbicides.



Figure 43. Crop and weed conditions for the sugar beet experiments in May 2012. Main picture – field condition showing unsprayed tramlines used for the experimental treatments on the right hand side of the picture. Inset – close up of crop and weed conditions.



Figure 44. Patch application of spray between crop rows using the “Even-Spray” nozzle.

For the sugar beet crop it was concluded that:

- In conditions where large weeds such as volunteer potatoes are distinct from the crop canopy, spot application of selective or non-selective herbicides is likely to give good control. However, it is recognised that weed control strategies used for a range of weed species in the beet crop may give some control of weeds such as volunteer potatoes and then such partially controlled weeds are difficult to detect with a spot spraying machine.
- Weed beet are difficult to control with the current approaches because:
 - Although detection by stereo vision has been shown to be feasible, further work is required to develop a practical system that is then likely to be expensive;
 - Targeting a spot spray would need a modification such as the use of a deflector bar;
 - Results indicate that control achieved with a glyphosate spray directed at the base of the weed beet plant gave variable levels of control.
- Patches of weed could be detected and controlled by inter-row and/or over the row applications of selective herbicides.

2.8 Economic analysis

A cost benefit analysis has been made based on experimental data, knowledge of engineering costs and general farm economic information derived from Nix (2012) and partner growers. The analysis is presented in the form of a spread sheet and is included as Appendix 1. The output is in the form of a weed control cost per hectare.

2.8.1 Key assumptions relating to the economic analysis

It is assumed that the precision spraying technology developed in this project would be implemented as an additional capability to a vision guided band sprayer. This is important economically as it allows the machine to be utilised for a larger proportion of the season than would be the case if its only function was the control large broadleaf weeds.

Analysis is based on a 6 m (3 bed) machine with a working speed of 5.0 km/h in spot spray mode and between 8.0 and 10.0 km/h in band or patch spraying mode. Fifty, 8 hour days are assumed to be available each year and a field efficiency factor of 0.75 is used to make allowance for travelling, headland turns and in-field set-up operations. Depreciation is 20% of capital cost and an additional 5% pa is allowed for maintenance.

2.8.2. Scenarios for comparison in the economic analysis

Three different scenarios are compared for each of the three crops covered in this project. The first is the current situation in which weed control is maintained using a combination of overall spraying and inter-row cultivation with a small allowance in vegetables for crop lost or abandoned due to weed infestation. The second is an anticipation of the situation in 2015 by which time it is expected that several important herbicides will have been lost (e.g. Pendimethalin in 2013, loxynil in 2015). In this scenario there is increasing use of inter-row cultivation, some use of hand labour and an increase in crop loss due bad weed infestation. These are compared against the proposed technology in which the new sprayer is used in spot spray mode to control problem broadleaf weeds such as potatoes, and in band spray mode for general weed control. Spot spray treatments are assumed to be with glyphosate. Band spraying inter-row (60% of area) is also assumed to be with glyphosate and selective herbicides band sprayed in-row.

2.8.3 Results from the economic analysis

The proposed new strategy using a combination of spot, band and overall spraying compares favourably (18% saving) with the current weed control strategy in leeks and indicates a 40% saving over the projected situation in 2015.

The situation in onions is similar to that of leeks except that the current herbicide situation is slightly better in onions and so there generally no need for inter-row cultivation which is a relatively expensive operation. The new strategy represents a 1% saving over the current situation and a 40 % saving over the projected situation in 2015.

Sugar beet production is currently under very much less pressure than in vegetables with fewer important herbicide withdrawals. Existing herbicide programmes generally achieve adequate weed control and so despite a saving on herbicide, the proposed strategy is (14%) more expensive overall. However, if as predicted, that situation changes in 2015, even in sugar beet the proposed strategy is expected to result in a 14% reduction in costs.

2.8.4 Discussion of the economic analysis

As presented the economic analysis does not include the potential benefit of altering the banded herbicide application according to a weed patch detection system such as the one developed in this work. The savings are highly dependent on the quantity and distribution

of weeds, but it might be reasonable to expect an overall reduction of between 25 and 50%. If we take the lower figure this would equate to a £9.0/ha saving (based on two banded applications). For vegetables this equates to a further 3% reduction in total weed control costs and in sugar beet the percentage is higher at 4% due to lower total costs.

Selective herbicides are known to impact crop growth to varying degrees. Targeted application reduces the amount of herbicide in contact with the crop and will therefore reduce any negative effects, though these have not been quantified. One of the advantages of the proposed system is that it reduces the constraints on herbicide selection thus making the production process less susceptible to the risk of herbicide loss. Greater use of non-selective herbicides may also improve control of problem weeds. It is difficult to put a figure on these benefits.

Weed control has been a serious problem for growers wishing to grow without the use of synthetic herbicides. Bio-herbicides have generally proved to be impractical due to their very limited selectivity, their high cost and their high volumetric application rates. Physically targeting bio-herbicides onto target weeds may offer at least a partial solution to these problems.

One of the reasons that herbicides are being banned is that they are found in ground water. Spot application typically restricts application to 2% or less of a field area. Furthermore, most of that which is applied falls onto foliage leaving very little in contact with the soil. Together these factors are likely to reduce ground water contamination by two orders of magnitude. Whilst the legislative framework does not currently recognise this feature of spot spraying it might be argued that some currently banned active ingredients could be allowed if applied in this way.

2.8.5 Conclusions from the economic analysis

The technology is cost effective in leeks and marginally cost effective in onions under current conditions. The technology is likely to become very cost effective in both onion and leek production as herbicide legislation becomes more restrictive.

There are a number of benefits accruing from the technology that are difficult to quantify financially but may justify investment even when a basic analysis is marginal:

- Increases flexibility of use of existing herbicides reducing risk for growers
- Improved control of problem weeds

- Environmental benefit of reduced inputs
- Potential for reduced phytotoxic effects on crop

2.8.6 *Application for an Extension of Authorisation for Minor Uses (EAMU)*

A key issue relating to the potential use of the system is a framework for the approvals of herbicides, particularly non-selective herbicides, for the crop/weed conditions for which spot and patch application may be relevant. As part of the project, a case was assembled by HDC staff for an “Extension of Authorisation for Minor Uses (EAMU)” relating to the spot application of glyphosate to control large weeds in a range of vegetable crops. This application was accepted in March 2013 - details of which can now be obtained from the Chemicals Regulations Directorate website.

Conclusions

It is concluded that a practical system has been developed for treating large weeds in vegetable and sugar beet crops by the spot application of selective and non-selective herbicides and to detect and treat patches of weeds in widely spaced row crops. Field trials with a full-scale experimental machine showed that the system was capable of:

- Detecting high percentages (circa 95%) of large weeds in crops such as onion, leek and sugar beet and applying selective and non-selective herbicides to detected weeds to give high levels of weed control.
- The application of non-selective herbicides at the full recommended field dose gave a rapid and complete kill of detected weeds with commercially acceptable levels of crop damage – this kill was noticeably faster and more efficacious than when using selective herbicide mixtures.
- Measurements of the spray deposits on crop plants adjacent to spot treated weeds showed that the target weeds had at least an order of magnitude greater deposits than did the crop plants. This was also reflected in assessments of glyphosate residue levels in crop plants growing very close to spot treated weeds where no detectable residues were found in crop plants of a harvestable size.
- A system of detecting patches of small weeds in row crops based on an assessment of plant material in the inter-row gap was shown to be feasible and the basis for the targeted application of selective herbicide treatments over the crop row with the option of using non- selective herbicides between the rows.
- Assessments of the economic viability of operating a spot application system as part of an intelligent band sprayer concluded that this would give financial savings in

many horticultural crops and that the potential for such savings will increase as the availability of selective herbicides reduces.

Knowledge and Technology Transfer

Papers

Miller, P.C.H.; Tillett, N.D.; Hague, T.; Lane, A.G. (2012). The development and field evaluation of a system for the spot treatment of volunteer potatoes in vegetable crops. *Aspects of Applied Biology*, 114, International Advances in Pesticide Application, pp113 – 120.

Miller, P.C.H.; Tillett, N.D.; Swan, T.; Tuck, C.R.; Lane, A.G. (2012). The development and evaluation of nozzle systems for use in targeted spot spraying applications. *Aspects of Applied Biology*, 114, International Advances in Pesticide Application, pp159 – 166.

Presentations

- Features of nozzle development for spot application presented at “Cereals 2010” in June 2010
- Presentation at “EuroOnion” in October 2010
- Elements of the project work included in a presentation at the “Crop World” event in December 2010
- Aspects of the project work on weed detection included in a presentation at the “Smart Sensors” event organized by IAgRE in March 2010
- Project work included in a presentation to the Horticultural LINK Programme Management Committee in March 2010.
- To “Food Research Partnership” on engineering in agriculture that included spot spraying as an example. 16th June 2011, Westminster
- On precision weed control at HDC open afternoon at Stockbridge house, 30th June 2011
- To Cambridge Farm Machinery Club November 2011
- To the BCPC Weeds Review, 9th November 2011, and reported in Farmers Weekly
- At Beijing Agricultural University, China, December 2011
- To Vegetable Agronomists Association meeting at PGRO January 2012
- At farmer meetings organized by Bayer CropScience – Winter 2011/12
- Article in NIAB “Landmark Bulletin” – June 2013.

Final project demonstration

A final demonstration of the project outputs was arranged in conjunction with HDC and Elsoms Ltd and was held as part of the Open Days on the 10th and 11th October 2012. Leek plants were grown and transplanted to represent a typical crop condition for demonstration purposes. Potatoes were also grown separately and transplanted into the leek crop – see Figure 45. In addition to the field demonstration, a demonstration of the nozzle systems used on the machine was arranged in the display tent at the event.



Figure 45. Final project demonstration held in conjunction with Elsoms Open Day in October 2012

The demonstration attracted a useful response from key people within the industry and enabled the capabilities of the approach to be visualized at first hand by those attending the event.

Acknowledgements

The work was conducted by a project consortium as part of the Horticultural LINK programme involving AHDB HDC, Potato Council, BBRO, NIAB TAG, Tillett and Hague Ltd, Garford Farm Machinery Ltd, Hypro EU Ltd, Monsanto UK Ltd, Robydome Ltd, The Allium and Brassica Centre, F B Parrish and Sons, Newton Farms, Allpress Farms and A Findley. Thanks are due to all those who contributed to a successful study, including:

Trevor Swan – Hypro EU Ltd

Philip and Michael Garford – Garford Farm Machinery Ltd

Cathy Knott and Peter Lutman as consultants to the project team

Manda Sansom from Monsanto UK Ltd

David Cole and Robert Montgomery for monitoring progress and maintaining liaison with Defra and the Horticultural LINK PMC
Sue Cowgill and Gary Collins - the Potato Council
Paul Cripsey and staff at F B Parrish and Sons
Patrick Allpress and David Norman representing Allpress Farms Ltd
Andy Richardson – Allium and Brassica Centre
James Willmott of Newton Farms
Alistair Findlay
Gary Milner – Robydome Ltd

References

- Doble, S J; Matthews, G M; Rutherford, I; Southcombe, E S E. (1985) A system for classifying hydraulic nozzles and other atomizers into categories of spray quality. Proceedings, Brighton Crop Protection Conference – Weeds: 1125 – 1133.
- Downey, D; Giles D K; Slaughter, D C. (2004) Pulsed-jet microspray applications for high spatial resolution of deposition on biological targets. *Atomisation and Sprays*, **14**, 93 – 109.
- Giles, D K; Downey, D; Slaughter, D C; Brevis-Acuna, J C; Lanini, W T. (2004) Herbicide micro-dosing for weed control in field –grown processing tomatoes. *Applied Engineering in Agriculture*, **20(6)**, 735 – 743.
- Hague T, Tillett N D, Wheeler H. (2006) Automated crop and weed monitoring in widely spaced cereals. *Precision Agriculture*, **7**: 21-32.
- Lefebvre, A.H. (1989) *Atomization and Sprays*. Hemisphere Publishing Corporation.
- Lund, I; Jensen, P K (2002). Application technology for band spraying. Correlation between liquid band distribution and biological efficacy. *Aspects of Applied Biology*, **66**, International advances in pesticide application: 107-114.
- Miller, P.C.H.; Butler Ellis, M.C.; Bateman, R.; Lane, A.G.; O’Sullivan, C.M.; Tuck, C.R.; Robinson, T.H.(2010a). Deposit distributions on targets with different geometries and treated with a range of spray characteristics. *Aspects of Applied Biology* **99**, International Advances in Pesticide Application: 241 – 248.

Miller, P C H; Tillett, N D; Hague, T; Lane, A G (2010b). Minimising the impact of weed control in vegetables by weed detection and spot herbicide application. HDC Project Report. Project Ref: FV 307.

Miller, P C H; Tillett, N D; Hague, T; Lane, A G (2006). The development of methods to control volunteer potatoes in a range of vegetable crops. Report to HDC for Project Ref: FV 281.

Nix, J. Farm Management Pocketbook. 42nd Edition (2012). Agro Business Consultants Ltd.

Tuck, C.R.; Butler Ellis, M.C.; Miller, P.C.H. (1997). Techniques for measuring droplet size and velocity distributions in agricultural sprays. Crop Protection, **16**, (7); 619- 628

Appendix 1 : Calculations to examine the economics of operating the system

All costs at 2012 levels	Reducing herbicides in row crops - Cost Benefit								
	Leeks			Onions			Sugar Beet		
	Current situation (2012)	No Action Situation (2015)	Proposed strategy	Current situation (2012)	No Action Situation (2015)	Proposed strategy	Current situation (2012)	No Action Situation (2015)	Proposed strategy
Costs									
General parameters									
Total workable days per season			50			50			50
Hours in working day			8			8			8
Max working hours per season			400			400			400
Capital cost (£)			45000			45000			45000
Depreciation at 20% of cap cost (£/yr)			9000			9000			9000
Maintenance costs at 5% of cap cost (£/yr)			2250			2250			2250
Hrly cost of ownership (over max working hrs)			28.1			28.1			28.1
Variable cost, tractor +driver (£/hr)			21			21			21
Machine and driver cost (£/hr)			49.13			49.13			49.13
Field efficiency factor (0-1)			0.75			0.75			0.75
Working width (m)			6			6			6
Spot spray mode									
Forward speed (km/hr)			5			5			5
Spot work rate (ha/hr)			3			3			3
Actual work rate after field efficiency (ha/hr)			2.3			2.3			2.3
Machinery and driver cost (£/ha)			21.83			21.83			21.83
Cost of spot treatment herbicide (£/ha)			1			1			1
Cost of one Spot spray pass (£/ha)			22.83			22.83			22.83
Band spray mode									
Forward speed (km/hr)			8			8			10
Spot work rate (ha/hr)			4.8			4.8			6
Actual work rate after field efficiency (ha/hr)			3.6			3.6			4.5
Machinery and driver cost (£/ha)			13.65			13.65			10.92
Cost of banded herbicide (£/ha)			18			18			18
Cost of one Band spray pass (£/ha)			31.65			31.65			28.92
Crop treatment strategy									
Number of spot treatments per crop			2			2			1
Total cost of spot weeding (£/ha)			45.67			45.67			22.83
Number of Band treatments per crop			2			2			2
Total cost of band spray (£/ha)			63.29			63.29			57.83
Capacity crop area			277			277			450
Inter-row hoeing									
Inter-row hoeing cost (£/ha)	44	44	44	44	44	44	44	44	44
No of inter-row hoe passes	1	2	1	0	2	1	0.3	0.5	0.3
Total cost of inter-row cultivation (£/ha)	44	88	44	0	88	44	13.2	22	13.2
Conventional spraying									
No of conventional herbicide spray passes	5	3	1	5	3	1	4.5	4.5	3
Contract/Farm sprayer charge/cost (£/ha)	12	12	12	12	12	12	10	10	10
Variable herbicide cost per treatment (£/ha)	27	27	27	27	27	27	27	27	27
Total cost of herbicide spraying (£/ha)	195	117	39	195	117	39	166.5	166.5	111
Hand weeding									
Variable average cost hand weeding (£/ha)	0	110	0	0	110	0	0	50	0
Abandoned crop due to weed infestation									
Av % of crop abandoned/lost due to weed	1	2	1	1	2	1	0	0	0
Establishment cost (rent, cult, seed, fert, pre-em etc) (£/ha)	2400	2400	2400	2400	2400	2400	1900	1900	1900
Loss due to abandoned/lost crop (27*28/100)	24	48	24	24	48	24	0	0	0
Total weed control costs including capital depreciation (£/ha)	263	363	216	219	363	216	180	239	205
Saving using proposed strategy (%)	18	41		1	41		-14	14	

Key

Grey cells are user inputs

White cells are figure derived from formulae