

Project title: Internal browning of carrot: investigating a link with the viral diseases PYFV and CMD

Project number: FV 382a

Project leader: Adrian Fox, Fera

Report: Final report, May 2013

Key staff: Anna Skelton
Ian Adams
Roy Macarthur
Val Harju
Mark Daly
Stephen Forde
Simon Conyers

Location of project: Fera, Sand Hutton, York

Industry Representative: Howard Hinds, Root Crop Consultancy Ltd, Hoveringham, NG13 7JP

Date project commenced: April 2012

Date project completed (or expected completion date): April 2013

DISCLAIMER

AHDB, operating through its HDC division seeks to ensure that the information contained within this document is accurate at the time of printing. No warranty is given in respect thereof and, to the maximum extent permitted by law the Agriculture and Horticulture Development Board accepts no liability for loss, damage or injury howsoever caused (including that caused by negligence) or suffered directly or indirectly in relation to information and opinions contained in or omitted from this document.

Copyright, Agriculture and Horticulture Development Board 2013. All rights reserved.

No part of this publication may be reproduced in any material form (including by photocopy or storage in any medium by electronic means) or any copy or adaptation stored, published or distributed (by physical, electronic or other means) without the prior permission in writing of the Agriculture and Horticulture Development Board, other than by reproduction in an unmodified form for the sole purpose of use as an information resource when the Agriculture and Horticulture Development Board or HDC is clearly acknowledged as the source, or in accordance with the provisions of the Copyright, Designs and Patents Act 1988. All rights reserved.

AHDB (logo) is a registered trademark of the Agriculture and Horticulture Development Board.

HDC is a registered trademark of the Agriculture and Horticulture Development Board, for use by its HDC division.

All other trademarks, logos and brand names contained in this publication are the trademarks of their respective holders. No rights are granted without the prior written permission of the relevant owners.

The results and conclusions in this report are based on an investigation conducted over a one-year period. The conditions under which the experiments were carried out and the results have been reported in detail and with accuracy. However, because of the biological nature of the work it must be borne in mind that different circumstances and conditions could produce different results. Therefore, care must be taken with interpretation of the results, especially if they are used as the basis for commercial product recommendations.

AUTHENTICATION

We declare that this work was done under our supervision according to the procedures described herein and that the report represents a true and accurate record of the results obtained.

Adrian Fox
Lead Virologist
Fera

Signature Date

Ian Adams
Senior Molecular Researcher
Fera

Signature Date

Report authorised by:

[Name]
[Position]
[Organisation]

Signature Date

[Name]
[Position]
[Organisation]

Signature Date

CONTENTS

GROWER SUMMARY	1
Headline.....	1
Background.....	1
Summary of the project and key findings.....	2
Financial benefits.....	3
Action points.....	3
Science Section	5
Introduction.....	5
Materials and methods.....	12
Results.....	20
Discussion.....	34
Conclusions.....	40
Knowledge and technology transfer.....	41
Glossary.....	43
References.....	43
Appendices.....	48

GROWER SUMMARY

Headline

Internal necrosis of carrot is strongly linked to the aphid-transmitted Carrot Yellow Leaf Virus. This virus was first reported in the UK in 1979, but has not been previously linked to root symptoms. Specific diagnostic tests have been developed for this virus and other carrot viruses.

Background

The principal viruses affecting carrot crops in the UK are Parsnip Yellow Fleck Virus (PYFV) and the Carrot Motley Dwarf (CMD) complex consisting of Carrot Red Leaf Virus (CtRLV), Carrot Mottle Virus (CMoV) and Carrot Red Leaf-associated RNA (CtRLVaRNA). These viruses affect crops sporadically, but when they occur they can have devastating consequences.

The presence of viruses has been associated with internal necrosis around the root core extending from crown to tip; this has been observed in carrot crops for at least the last 10 years. The 2009 growing season saw some growers losing up to 10% of yield because of these symptoms. As the symptoms tend to be internal there are obvious practical issues in grading out affected carrots. For carrots destined for processing, this will lead to rejection of total consignments at processors and pack-houses.

Results of a limited survey in 2010 (HDC project FV 382, Fox, 2011) suggested a possible weak link between the presence of internal browning/root necrosis symptoms with viruses for the CMD complex. Detection of these viruses is carried out using conventional polymerase chain reaction (PCR) methods from assays developed following HDC project FV 228a (Morgan, 2004). Development of a suite of real-time RT-PCR diagnostic tests would bring advantages in sensitivity and turnaround time. In addition, the amenability of real-time PCR to automation would allow high throughput testing methods to be used, making epidemiological studies practical and affordable. Assays developed within this project have been used to ascertain which viruses are present within symptomatic carrots and to detect the presence of multiple viruses in carrot crops.

Traditionally, linking a pathogen with an expressed symptom requires demonstrating 'Koch's Postulates', where a pathogen is isolated from a symptomatic host and then back-inoculated into the original host species to induce the original symptom. Where a complex

of viruses may be affecting a host, or where there may be environmental or agronomic influences on symptom development (e.g. temperature, moisture, time from exposure, time in ground/crop growth stage, etc.), trying to artificially induce symptoms can be challenging. A statistical model has been developed to establish a link based upon testing similar numbers of affected and unaffected carrots for the presence of multiple pathogens. We believe this model to have broad applications in plant pathology, where infection and disease are often anecdotally linked but lack statistical support.

Traditional diagnostic methods are targeted towards specific known pathogens. By using a metagenomic approach using novel sequencing technology, other possible causes of internal browning can be identified. This technology has already been used to describe previously unknown plant viruses such as Gayfeather Mild Mottle Virus (Adams *et al.*, 2009) and Watercress White Vein Virus (Harju *et al.*, 2012). This would ascertain whether other viruses/pathogens were present in necrosis-affected carrots.

Summary of the project and key findings

Carrot samples were collected from a crop exhibiting 3% necrosis symptoms. Approximately equal numbers of affected and unaffected carrots were included in the sample (102 affected: 99 unaffected). These samples were tested for the presence of the established carrot viruses Carrot Red Leaf Virus (CtRLV), Carrot Mottle Virus (CMoV), Carrot Red Leaf-associated Virus (CtRLVaRNA) and Parsnip Yellow Fleck Virus (PYFV). The presence of these viruses did not correlate to symptomatic carrot roots, either as single viruses or in combinations. Field weeds from around fields known to be associated with viral necrosis were tested, but few positive results were obtained for these established carrot viruses.

A sub-sample of 12 affected and 12 unaffected carrots of mixed virus status was subjected to non-targeted analysis (next-generation sequencing; NGS). The results from these tests showed an unexpected virus – Carrot Yellow Leaf Virus (CYLV) – to be associated to the presence of internal carrot necrosis in the sub-sample. A virus closely related to CYLV was also found to be present in the non-CYLV-infected symptomatic roots, but due to the low incidence of this virus in the sub-sample, no meaningful conclusions can be drawn on the importance of this finding. Additionally, several other novel plant viruses were found within the sub-sampled carrots. These were present in low numbers and did not appear to bear any relationship to the presence of necrosis in carrot roots.

Because of the high prevalence of CYLV in the sub-sampled symptomatic carrots, a specific diagnostic test was designed and the main field sample was tested for this virus. Of the affected (symptomatic) carrots, 98% were positive for CYLV, and of the unaffected (symptomless) carrots 22% were found to be positive for CYLV. This virus had the closest association with necrosis across all carrots tested, either as a single virus, or in combination with other viruses. Because necrosis without the presence of CYLV is estimated to be rare in the original sampled population, if CYLV is the causative agent of necrosis, removal of this pathogen is estimated to potentially reduce necrosis by 96%. We believe this to be the first report to link CYLV to root necrosis.

Financial benefits

Unlike external root symptoms traditionally associated with PYFV (e.g. cigar shaped roots), internal necrosis cannot easily be graded out. However:

- (i) The primary causal pathogen is now known. A better understanding of the relationship between virus infection and internal browning should lead to a reduced incidence of these symptoms through improved management strategies.
- (ii) This, in turn, should lead to reduced waste from the industry both through reducing numbers of carrots rejected on the grading line and numbers of crops rejected at processors and pack-houses.

Advanced diagnostic assays have been designed and will be offered as a diagnostic service, helping UK carrot growers to save money through reduced waste and rejected produce. Additionally, the use of non-targeted diagnostic approaches to plant pathology applications have been successfully demonstrated and will hopefully be further developed and incorporated into a future diagnostic service; this will potentially reduce waste and further increase growers' income.

Action points

- CYLV can be transmitted by both willow-carrot aphid and parsnip aphid; growers need to monitor both species. At present, only willow-carrot aphid is shown on Rothamsted and HDC Pest Bulletin weekly reports.
- CYLV is carried semi-persistently in the aphid and is retained within an infectious individual for several days. Unlike PYFV, the virus can recycle within carrots leading to sequential transmission. Control programmes need to be extended even when

low numbers of aphids are found, which may mean continuation of insecticide treatments beyond May and June (usually the peak time for willow-carrot aphid) and into July, August, September and even October.

- Yellow traps are the best approach to monitor local carrot aphid populations (both species) for farms in order to assess when programmes/treatments need to be started, maintained or stopped.

SCIENCE SECTION

Introduction

Viruses of carrot

Globally, more than 30 viruses are known to affect carrot. Some of these, such as Carrot Virus Y, have a limited geographic range and have not been detected in the UK or Europe. Others, such as Clover Yellow Vein Virus and Parsnip Mosaic Virus are known to occur in the UK and can infect carrot experimentally but have never been found to infect carrots naturally. Viruses require a vector for transfer from host to host. In some cases this can be direct plant to plant contact, but more commonly this will be through sap transfer from cutting tools, e.g. in crops where grafting is part of the production cycle, or through the act of pests feeding on infected plants and then moving to other hosts. The main viruses affecting carrot are either insect transmitted, e.g. by aphids, or are transmitted by nematodes.

Aphid transmitted viruses

The principle viruses affecting carrot crops in the UK are Parsnip Yellow Fleck Virus (PYFV) and the Carrot Motley Dwarf (CMD) complex consisting of Carrot Red Leaf Virus (CtRLV), Carrot Mottle Virus (CMoV) and Carrot Red Leaf-associated RNA (CtRLVaRNA). Both PYFV and the CMD complex are transmitted by the willow-carrot aphid (*Cavariella aegopodii*). These viruses affect crops sporadically but when they occur they can have devastating consequences. Foliar and root symptoms associated with carrot viruses are shown in Figure 1.



Figure 1. Carrot samples submitted as part of the 2010 survey and tested for the presence of PYFV and CMD viruses. (a) Showing blackening/necrosis of root tip. This sample was positive for Carrot Mottle Virus. (b) External browning of carrot root. This sample was positive for Carrot Mottle Virus. (c) Foliar reddening and chlorosis. Sample positive for Carrot Mottle Virus and Carrot Red Leaf-associated viral RNA. (d) Internal browning. Sample positive for CMD.

Parsnip Yellow Fleck Virus (PYFV; *Secoviridae*; *Sequivirus*): PYFV is aphid-transmitted and occurs only in association with a helper virus, Anthriscus Yellows Virus (AYV), which is necessary for aphid transmission. However, carrot is not susceptible to AYV. Early infection with PYFV can result in severe stunting and the death of individual plants. Later in the season larger plants can develop mottled foliage; discoloured with yellow flecks. Affected plants may develop secondary and/or misshapen roots, whilst tops may die back. Infection with this virus has also been historically associated with the development of symptoms similar to crown rot.

Carrot Motley Dwarf (CMD) complex consists of three viruses:

- Carrot Red Leaf Virus (CtRLV; *Luteoviridae*; *Polerovirus*)
- Carrot Mottle Virus (CMoV; Unassigned; *Umbravirus*)
- Carrot Red Leaf-associated viral RNA (CtRLVaRNA; Unassigned)

The CMD complex is also aphid-transmitted. CtRLVaRNA is dependent upon Carrot Red Leaf Virus for aphid-mediated transmission and within plant movement. CtRLV also acts as a helper virus for the aphid transmission of CMoV. Plants may become infected with the individual component viruses; however, it is more common to find the viruses in mixed infections in symptomatic plants. CMD complex causes reddening and chlorosis (yellowing) of foliage with variable amounts of mottling as well as severe stunting and yield losses.

There are several other viruses that are known to affect carrot and which have been recorded in the UK, but these are not considered to be common in carrot crops.

Celery Mosaic Virus (CeMV; *Potyviridae*; *Potyvirus*): This virus was first found in the UK in the late 1960s affecting celery crops (Pemberton and Frost, 1974), but also found to be present in wild hemlock and other weed species. The virus causes a mosaic on carrot. It is transmitted in a non-persistent manner, which means it is vectored by a broad range of aphid species including the willow-carrot aphid (*Cavariella aegopodii*) and the parsnip aphid (*C. pastinacae*).

Cucumber Mosaic Virus (CMV; *Bromoviridae*; *Cucumovirus*): Reputed to have the broadest known host range of any plant virus, affecting at least 1200 species in over 100 families of dicotyledonous and monocotyledonous plants (DPV, 2003). Specific symptoms on carrot are unknown. The virus is aphid-transmitted in a non-persistent manner, with over 60 species known to have the ability to transmit the virus, including the willow-carrot aphid.

Carrot Yellow Leaf Virus (CYLV; *Closteroviridae*; *Closterovirus*): First reported in the UK in hogweed (*Heracleum sphondylium*) as Hogweed 6 Virus (Bem and Murrant, 1979a); later the taxonomy was reassigned as CYLV. Foliar symptoms in carrot include yellowing and reddening. It is transmitted by *Cavariella* spp. including the willow-carrot aphid and the parsnip aphid. The virus can help the vector transmission of Heracleum Latent Virus.

Heracleum Latent Virus (HLV; *Betaflexiviridae*; *Vitivirus*): First reported in the UK in hogweed (Bem and Murrant 1979a), it was subsequently shown to affect carrot and to be transmitted by aphids including *Cavariella* spp. (Bem and Murrant, 1979b.)

Nematode transmitted viruses

- Strawberry Latent Ringspot Virus (SLRSV; *Secoviridae*, *Unassigned*)
- Arabis Mosaic Virus (ArMV; *Secoviridae*, *Nepovirus*)
- Tobacco Ringspot Virus (TRSV; *Secoviridae*, *Nepovirus*)
- Tomato Black Ring Virus (TBRV; *Secoviridae*; *Nepovirus*) (ICTV, 2012)

The four nematode-transmitted viruses listed above that are known to infect carrots have a very wide host range of plants, including fruit crops such as strawberry and raspberry and many ornamental species. Additionally, they are known to affect weed species and these could be a reservoir for viruses acting as a bridge between crops.

Crown rot-type symptoms – internal necrosis around the core extending from crown to tip – have been associated with the presence of viruses. The 2009 growing season saw some growers having up to 10% of yield affected by these symptoms. As the symptoms tend to be internal there are obvious practical issues in grading out affected carrots. Results of a limited survey in 2010 (Fox, 2011) suggested a possible link between the presence of internal browning/root necrosis symptoms with viruses in the CMD complex.

Diagnostic development

Detection of these viruses is currently carried out using conventional polymerase chain reaction (PCR) methods. Further development of these assays to produce a suite of real-time RT-PCR diagnostic tests would bring advantages in sensitivity and turnaround time. In addition, the amenability of real-time PCR to automation would allow high throughput testing methods to be used, making future epidemiological studies practical and affordable. The real-time PCR assays were validated against virus isolates from UK sources and field isolates from this study. Additionally, previous diagnostic developments have been dependent upon targeted diagnostic technologies where a pathologist must know the likely causes of a disease to apply the appropriate test. Within this study, non-targeted diagnostic techniques are also applied. These cutting edge technologies allow a more open-ended search for pathogens, leading to the potential for finding unexpected or novel pathogens in diagnostic samples.

TaqMan[®] real-time PCR technology: The main nucleic acid-based detection methods are the conventional PCR or RT-PCR and the Real-Time RT-PCR methods. The latter method (especially the TaqMan[®] chemistry) uses an internal primer located between a specific pair of primers that is labelled at opposite ends with reporter and quencher dyes. The intact

probe is in a non-fluorescence state, as the quencher absorbs fluorescence emitted by the reporter. During amplification, the reporter is separated from the rest of the probe resulting in fluorescence, which can be detected. This fluorescence is proportional to the quantity of amplified product (ΔR_n). The cycle threshold (C_t) value is related to the log of the number of target RNA molecules in the reaction (see Figure 2). This method has been applied to the detection of various plant pathogens including viruses and has been shown to be the most sensitive detection method presently in use (Mumford *et al.*, 2004; Boonham *et al.*, 2002 and 2004; Korimbocus *et al.*, 2002).

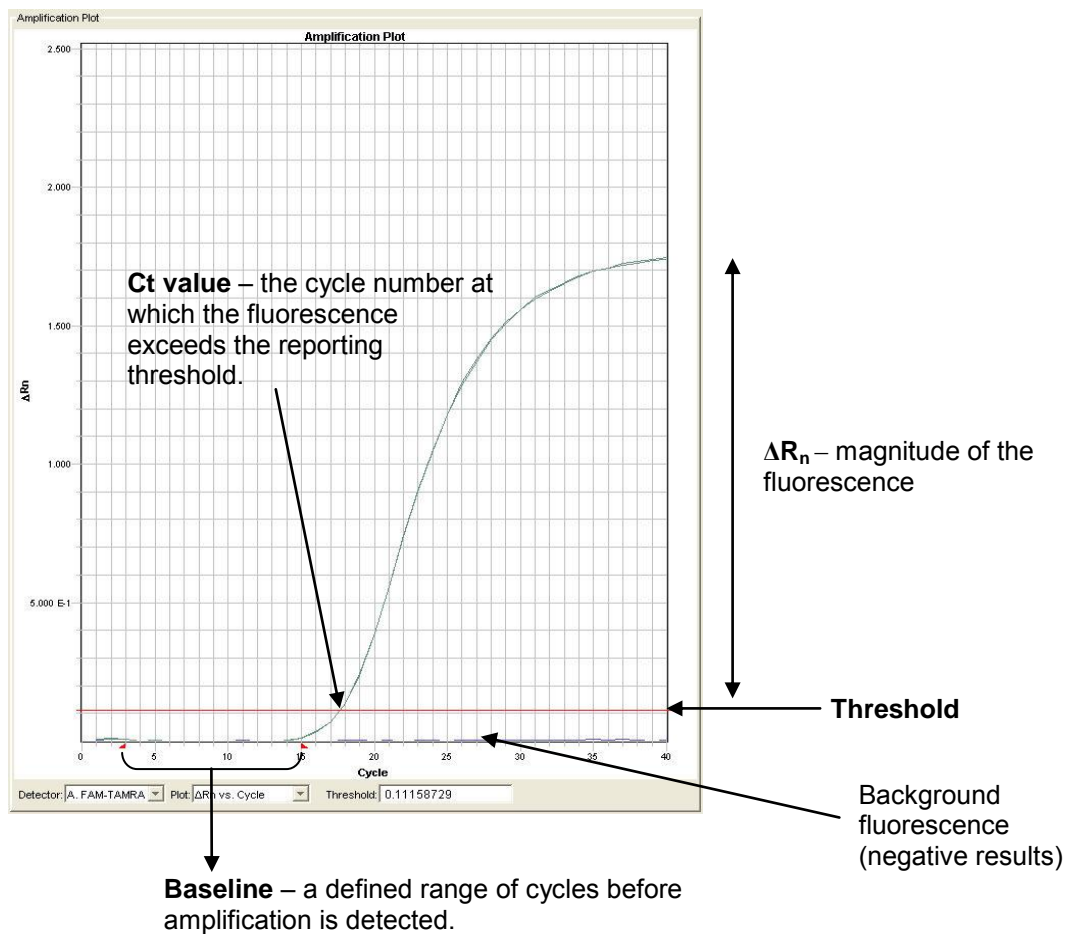

Figure 2: TaqMan[®] amplification plot showing key elements for interpretation of real-time PCR assays.

The assays developed within this project were used to ascertain which viruses are present within symptomatic carrots and the presence of multiple viruses in carrot crops. Sources of symptomatic and asymptomatic carrots with virus were recorded to look for viral influences leading to an understanding of the relationship between virus presence and the development of internal browning symptoms.

Next-generation sequencing (NGS): Traditional diagnostic methods are targeted towards specific known pathogens. By using a metagenomic approach utilising novel sequencing technology, other possible causes of internal browning can be identified. This technology has already been used to describe previously unknown plant viruses such as Gayfeather Mild Mottle Virus (Adams *et al.*, 2009) and Watercress White Vein Virus (Harju *et al.*, 2012) and to identify Maize Chlorotic Mottle Virus and Sugarcane Mosaic Virus causing Maize Lethal Necrosis in Kenya (Adams *et al.*, 2012). This would ascertain whether other viruses/pathogens were present in necrosis-affected carrots.

Field weeds as reservoirs of CMD

Within the previous HortLink project (Morgan, 2004), a survey of possible weed hosts of PYFV was carried out. A strong link with *Anthriscus* sp. (cow parsley) was indicated as a major reservoir of this virus into carrot fields. The results of this work also suggested that PYFV in hogweed was more closely related to PYFV isolates found in parsnip fields.

Recent work has suggested that CtRLV isolates from field weeds formed a distinct genetic clade to those found in carrot crops and therefore carrot sources of CMD were the primary reservoir for infections of this complex of viruses within carrot (Dez Barbara, personal communication). A supplementary survey of CMD viruses (to include CMoV and CtRLVaRNA) in hedgerow umbellifers and other weeds from around carrot fields should give further valuable data on the importance of weed hosts in the epidemiology of this virus complex.

CMD viruses and their influence on internal browning

To definitively link a pathogenic cause to an observed symptom it is necessary to demonstrate Koch's Postulates. These requirements were first described in 1890 and were intended to set a standard methodology for proof of a causal relationship consisting of three main criteria (adapted from Fredricks and Relman, 1996):

- i. The pathogen occurs in every individual with the disease/symptoms

- ii. There is specificity between presence of the pathogen and the symptom, i.e. it does not occur in asymptomatic individuals
- iii. The pathogen can be isolated, grown in pure culture and can induce the symptom on infecting a healthy individual.

Considering viruses as obligate pathogens, where a host's molecular processes are hijacked to enable replication and movement, it is not possible to obtain a 'pure culture' and the third postulate cannot be demonstrated. Added to that, where detection is carried out using molecular or serological methods, the pathogen may be detected when no disease symptoms are observed. This may be due to a number of factors, such as time elapsed post-inoculation, differences in host population susceptibility (e.g. varietal differences), or environmental considerations such as variations in temperature, humidity or light intensity. Therefore, *in sensu stricto*, Koch's Postulates cannot be demonstrated for a virus. For diseases induced by a single virus species, Koch's Postulates may be satisfied in their broadest interpretation; where a pathogen is isolated from a symptomatic host and then back-inoculated into the original host species to try and replicate the original symptom. Where a complex of viruses may be affecting a host or where there may be environmental or agronomic influences on symptom development (temperature, moisture, time from exposure, time in ground/crop growth stage, etc.), trying to artificially induce symptoms can be challenging.

During 2011, a small study was carried out to investigate a suspected link between the presence of internal browning and carrot viruses (Fox, 2011). The results from this study (see Figure 3) suggested a link between virus and the presence of browning in samples. Affected carrots had a higher relative incidence of virus infection than did unaffected carrots. However, the low numbers of samples and skewed sampling regime necessary to obtain the data meant that results were not conclusive.

It is accepted that demonstrating a mathematical relationship is not analogous to demonstrating a biological causative relationship. However, given the challenges described, demonstrating a statistical link would give grounds for further investigations to be carried out. To this end, a statistical model has been developed for use in this study to establish a link based upon testing equal numbers of affected and unaffected individuals for the presence of multiple pathogens. We believe this model could have broad applications in plant pathology where infection and disease are often anecdotally linked but lack a statistical or empirical basis.

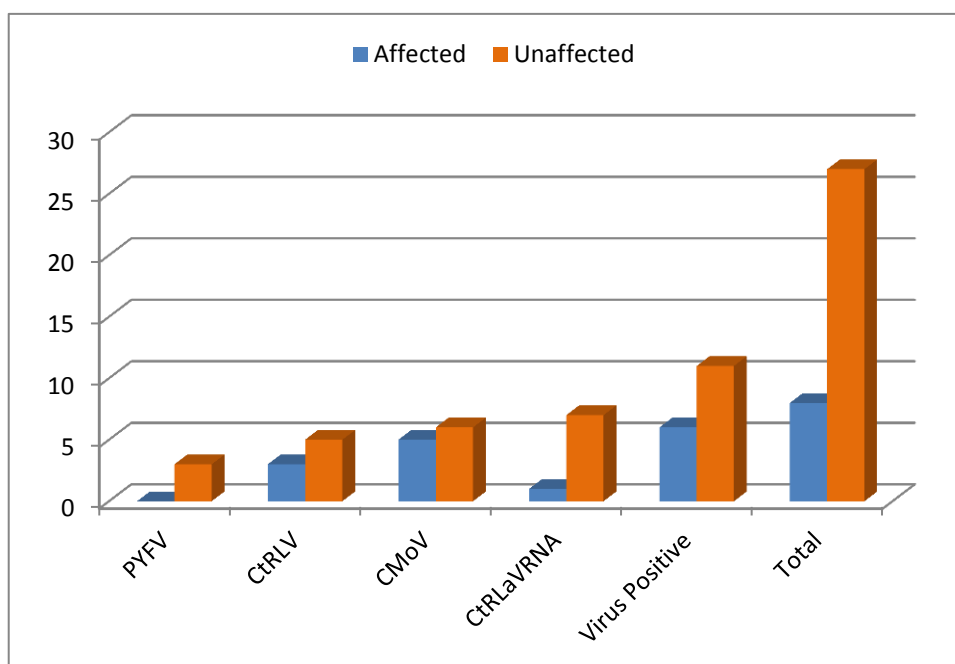

Figure 3: Results of 2011 carrot testing to investigate the influence of Carrot Motley Dwarf (CMD) complex on the presence of internal browning symptoms in carrot roots.

The aim of this project was to build upon previous work (Morgan, 2004 and Fox, 2011) to identify a link between carrot virus infections and internal browning in carrot roots. In addition to this aim, further work has been conducted to identify possible sources of carrot viruses from the Carrot Motley Dwarf complex in the environment.

Materials and methods

1: Diagnostic development: Design and validate a suite of real-time PCR assays

Real-time PCR assays have been designed to cover the suite of viruses associated with UK carrot crops; CtRLV, CtRLVaRNA, CMoV, PYFV and AYV. These have been validated against samples from the field study part of this project.

1.1. Nucleic acid extraction

The extraction of viral RNA was performed using the in-house Fera magnetic bead method.

1.2. Real-time PCR assay design

TaqMan[®] assays were designed using ABI Primer Express software, using sequences obtained from the National Center for Biotechnology (NCBI) database

(www.ncbi.nlm.nih.gov). The assays for CMoV, PYFV and AYV were redesigned using sequences obtained by NGS from field samples obtained during this study. These sequences will be deposited in the NCBI database in due course. The details of the different assays that were designed are described under the Results section (see Table 4).

1.3. Real-time PCR

Real-time PCR was performed under generic conditions, essentially as described previously (Mumford *et al.*, 2000), using TaqMan[®] core reagent kits (Applied Biosystems; Cat. No. 430 4441). Primers were used at a working concentration of 300 pM and probes at 100 pM, in each 25 µl reaction. Assays were run on Applied Biosystems (ABI) 7900 machines.

Machine program for a RNA template:

30 min at 48°C, 10 min at 95°C, then 40 cycles of 95°C for 15 sec and 60°C for 1 min.

1.4. Validation work

Validation of novel assays for detection should follow the following principles as recommended by the European and Mediterranean Plant Protection Organisation (EPPO/OEPP) in PM7/98 diagnostic standard (EPPO/OEPP 2010). This standard recommends the types of data that should be presented when validating assays for quality accreditation (e.g. ISO 17025). Whilst it is not currently the intention to accredit the assays designed under this project for this quality standard, the same principles for validation have been followed.

- Specificity – *In silico* analysis plus comparative testing. The sequences of known assays will be compared against known virus sequences to look for potential isolates which could be missed by the assay. The samples tested by conventional PCR as part of other parts of this project will also be tested using the new tests to investigate possible differences in the range of detection.
- Repeatability – Ensuring that the detection of the virus is repeatable at the limits of detection. This can be carried out as part of the testing of the first two aspects of this work.
- Robustness – Ensuring the assays are reliable for use. They are tested by different people, on different PCR machines. This can be carried out as part of the first two aspects of this work.

2: Studies on incidence of CMD viruses in field weeds and carrot crops

Focusing on a small number of fields where carrot viruses have been associated with high levels of root necrosis, samples of common umbelliferous weeds and carrots with foliar symptoms were collected. Sampling was on a range of dates as detailed at each site to cover temporal as well as spatial distribution of virus hosts. Field sites were chosen where there was a previous record of internal browning. As the largest dataset for this work was from areas to the south and east of York, fields in these areas were selected, as suggested by Howard Hinds of Root Crop Consultancy Ltd., and are shown in Figure 4.

The fields are identified below in Table 1 and Figure 4. Two fields were close to Long Lane, Heslington, York, YO10, and seven fields were close to Allertorpe Woods, near Pocklington, East Yorkshire, YO42.

Table 1. Locations and identification references for the fields sampled for umbelliferous weeds.

Postcode	Field Identifier	Grid Reference	Latitude	Longitude
YO10	1	SE 64428 49418	53.936877	-1.02009
YO10	2	SE 64232 49019	53.933315	-1.02316
YO42	1	SE 74106 47336	53.9168766	-0.87321
YO42	2	SE 73972 47615	53.919404	-0.87518
YO42	3	SE 74185 47680	53.91996009	-0.87192
YO42	4	SE 74301 48126	53.9239531	-0.87005
YO42	4A	SE 74298 47946	53.92233573	-0.87014
YO42	5	SE 73987 48206	53.92471123	-0.87481
YO42	6	SE 74270 48331	53.92579785	-0.87048

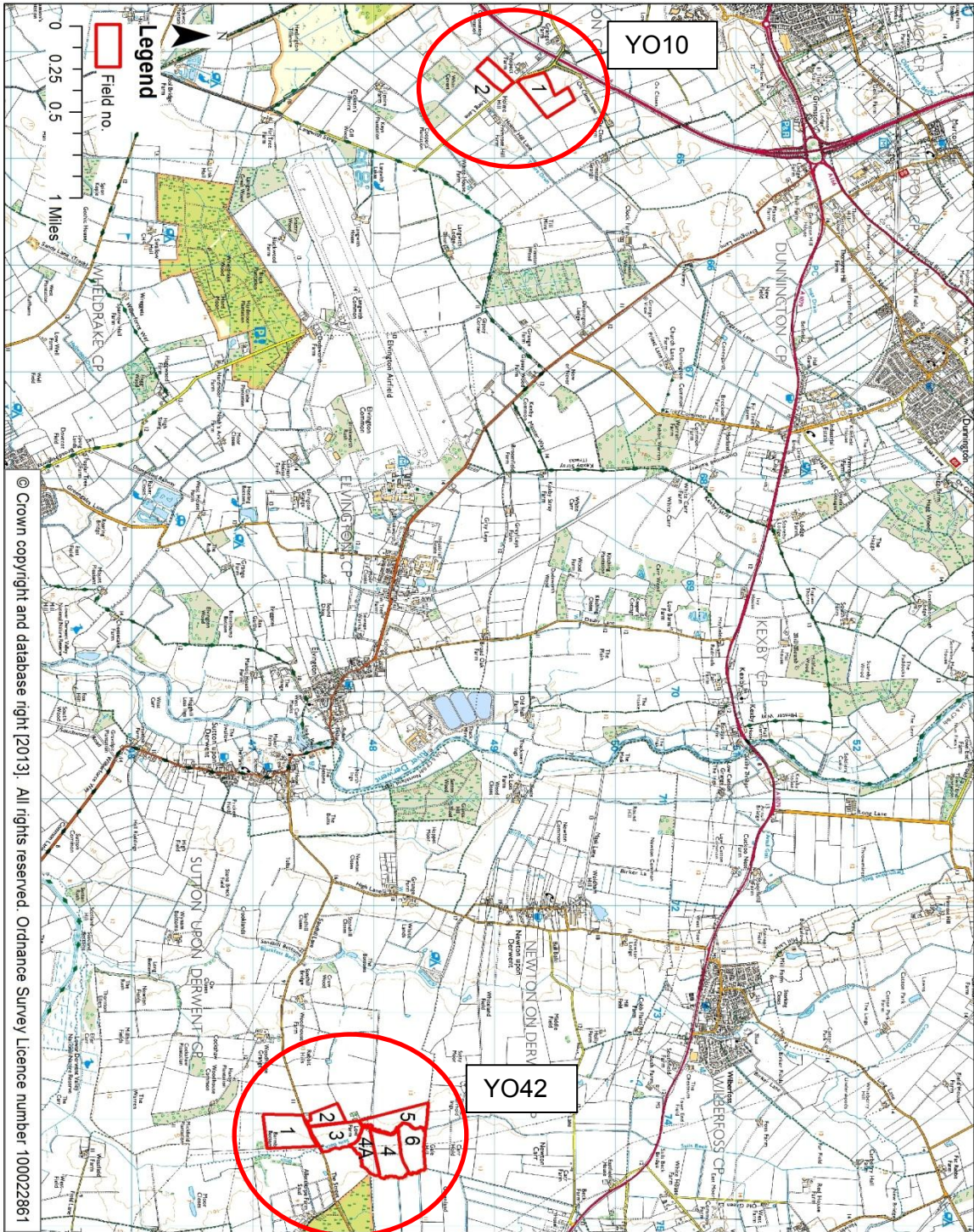

Figure 4. Map of the area to the southeast of York showing the location of field sites for weed sampling.

The relative numbers of samples tested for different weed species are detailed in Table 2. The numbers of samples collected reflect the abundance of weeds in the different fields, with hogweed being the most abundant weed in the sampled fields. The source of each sample can be found in the table in Appendix 1.

Table 2. The number and proportion of field weed samples.

Species	No. of fields sampled	No. of samples tested
Hogweed	9	58
Cow parsley	7	25
Hemlock	1	1
Rough chervil	2	3

Samples were tested using the conventional PCR method for the four common carrot viruses, as described in FV 328. The PCR products of virus-positive weed samples were subsequently submitted for sequencing (Eurofins/MWG-biotech) along with those from a selection of virus positive carrots. The phylogeny of viruses found in weeds was then investigated using Megan4 to provide data on the sources of viruses found affecting carrot crops. These data are presented in the Results section below.

3. The influence of viruses on the aetiology of internal browning

To compile a dataset on the viruses present in carrots with necrotic root symptoms, and in carrots showing foliar symptoms in the field, equal numbers of necrotic and non-necrotic 'control' carrots were collected from a crop exhibiting necrosis during grading. The carrots were grown in Gothic Back Field (YO19; SE 65486 445297; Latitude 53.899711, Longitude -1.0048628).

This field lies approximately 4.5 km south of the Heslington (YO10) site and 9 km west-south-west of the Pocklington (YO42) site where weed samples were collected.

3.1. On the grading line, carrots were cut until 100 affected carrots had been sampled. To achieve this required cutting 3300 carrots, an incidence level of 3%, with an even distribution of internal and external necrosis. A further 100 'unaffected' carrots were also sampled.

3.2. RNA was then extracted from the carrots using the RNA extraction procedure as per section 1.1, and tested for the presence of PYFV, CtRLV, CtRLVaRNA and CMoV using conventional PCR. The results from this test are in the Results section below.

3.3. Data from the sampling and testing aspects was then analysed using the following statistical model to investigate the potential influence of viral infections upon the development of necrotic root symptoms.

3.3.1. Statistical model for assessing the influence of viruses on internal browning

The extent to which necrosis may be caused by viruses was assessed by counting the proportion of carrots that are necrotic and testing equal numbers of necrotic and non-necrotic carrots for the presence of viruses. The table of statistical calculations can be found in Appendix 2.

Three proportions were observed:

- $P(N)$: Proportion of carrots that were necrotic
- $P(V|N)$: Proportion of necrotic carrots that contained a virus
- $P(V|\sim N)$: Proportion of non-necrotic carrots that contained a virus

Estimates of three proportions were derived:

- $P(V)$: Proportion of carrots that contained virus
- $P(N|V)$: Proportion of carrots with a virus that are necrotic
- $P(N|\sim V)$: Proportion of carrots without a virus that are necrotic

Estimates were derived from the law of total probability:

$$P(V) = P(V|N)P(N) + P(V|\sim N)(1 - P(N))$$

(Equation 1)

and Bayes' Theorem:

$$P(N|V) = \frac{P(V|N)P(N)}{P(V)}$$

$$P(N|\sim V) = \frac{P(\sim V|N)P(N)}{1 - P(V)}$$

(Equation 2)

The size of the uncertainty associated with observed proportions was estimated using a Modified Jeffreys interval [1], where given x 'positives' out of n observations, the probability p underlying the observed proportion is with confidence $1-\alpha$

$$B(\alpha/2, x + 0.5, n - x + 0.5) \leq p \leq B(1 - \alpha/2, x + 0.5, n - x + 0.5) \text{ if } 0 < x < n,$$

where $B(\alpha, b, c)$ is the α quantile of the $Beta(b, c)$ distribution

$$p \leq 1 - \alpha^{1/n} \text{ If } x=0, \text{ and}$$

$$p \leq \alpha^{1/n} \text{ If } x=n$$

(Equation 3)

The size of the predicted effect of removing a virus on the prevalence of necrosis expressed as the proportional reduction in prevalence was estimated using:

$$E = \frac{P(N) - P(N|\sim V)}{P(N)}$$

(Equation 4)

The uncertainty associated with derived estimates was estimated by generating independent random (uniform [0,1]) quantiles for each of the observed proportions (Equation 3) and calculating derived values using Equations 1 and 2. Ninety-five percent confidence intervals were taken from the 2.5th and 97.5th percentiles of 10,000 derived values.

3.4 Twelve affected and twelve unaffected carrots were also analysed using a metagenomic approach to ascertain the presence of other non-target viruses/pathogens that may be a

contributing cause of internal necrosis. The symptomatic and infection status of the carrots that were sequenced are summarised in Table 3.

RNA was extracted from frozen samples of carrot roots chosen for metagenomic analysis using RNeasy columns (Qiagen, UK). Extractions were performed as recommended by the manufacturer using RLC extraction buffer and on column DNase digestion. The carrot material was initially ground in liquid nitrogen.

An individually indexed library was then constructed from each sample using the TruSeq RNA LT library construction system (Illumina, UK) as per manufacturers' protocols. The libraries were then quantified using a Quant-IT high sensitivity Qubit kit (Invitrogen, UK) and checked for quality on a TapeStation (Agilent, UK). Twenty-four libraries were then run in batches of twelve on two flow cells of a MiSeq (Illumina), using a 500 cycle v2 sequencing kit. Two sets of 250 cycles and a 6-cycle index read were performed.

The resulting sequences were assembled using Trinity (Grabherr *et al.*, 2011) and the contigs compared to the NCBI nr database (Benson *et al.*, 2010) using BLASTx from the BLAST+ suite (Camacho *et al.*, 2009). MEGAN (Huson *et al.*, 2007) was used to analyse the BLAST results and extract virus-related sequences. Phylogenetic analysis was carried out using MEGA 5 (Tamura *et al.*, 2011).

Table 3. Initial PCR results from carrots submitted for subsequent metagenomic analysis. Numbers of individual virus positives are presented as cases of virus. In samples with multiple viruses this has been recorded as a case of each virus, therefore there will be more cases of virus than carrots tested.

	Symptomatic	Non-symptomatic
No. tested	12	12
Negative	3	6
PYFV	3	3
CaRLV	6	5
CMoV	6	2
CaRLaVRNA	0	0
Multiple infections	6	4

4. Additional work carried out to investigate the presence of Carrot Yellow Leaf Virus and other novel virus sequences

Using the sequences derived from the metagenomic study, two real-time assays were designed for CYLV and one for the related virus (called Carrot Unclassified Caulimovirus [CUCV] for the purposes of this study) using Primer Express 2 (Applied Biosystems). The assays were designed *in silico* so as not to cross-react with each other. Due to the clear association between CYLV and necrotic carrots in the NGS sub-sample, this virus was selected for further study. After initial testing, the most sensitive and specific assay for CYLV was chosen and used for further work.

The assay designed to detect CYLV was used to test the initial field sample of affected and unaffected carrots. The RNA extracts from the 102 affected and 99 unaffected carrots were tested and the results of this testing were then included within the statistical analysis to look for correlations between the incidence of necrosis and the presence of this virus either singly or in co-infections.

Results

In the following section, results are presented as ‘cases’ of virus. Where a sample tested negative, this is one negative case. Where a sample is positive for a virus, this is recorded as one case of that virus. Where a sample is positive for multiple viruses it is recorded as one case of each virus. Therefore, for data regarding incidence of single viruses there will be more cases of virus than samples tested. Data are also presented to show the numbers and identities of mixed infections. For the statistical analysis (see Results section 3), the influence of both single and mixed infections was considered.

1: Diagnostic development: Design and validate a suite of real-time PCR assays

1.1. Real-time PCR assay design

TaqMan[®] assays were designed using ABI Primer Express software, using sequences obtained from the NCBI database (www.ncbi.nlm.nih.gov). The details of the different assays that were designed are described below.

Table 4. Real-time primer and probe sequences designed in this study

Virus	Forward	Reverse	Probe
PYFV	CAATATGCATGCTAGAAGGCTTTTC	TTATCCCAACCATAATACCATGCTT	TGGACTTCAACGTCTTTGTTATGGC CAATAGAC
AYV	GGCCGGATCTGTGTCTAGAGTTATA	GGCCGGATCTGTGTCTAGAGTTATA	GGCCGGATCTGTGTCTAGAGTTATA
CtRLV	CCCCGGTCTTGTTCAGTCT	GCCAAAWCCGGGTTTTGAR	AGAACAAGTTAGAAATMCCGCTTTG GAGAGC
CtRLVaRNA	CGKTTAGTTCGGATTACGACATAGT ATTT	CGKTTAGTTCGGATTACGACATAGT ATTT	CGKTTAGTTCGGATTACGACATAGT ATTT
CMoV	CCTACACGCCGCGATGA	CRACTGCGTGGACTTTTTCCG	AACGATATGGGAACCACGACCAGGG
CYLV†	AAGATTCTCTTGTAACGAAGGTTTC C	GCCGCCTCCACGATCAC	AGACCTCACTATGCTAAACCCGAGC CGG
CUCV†	GCCTCCCGCTTGTGGA	AGCCGCCAACGTCTATGAAG	AATAGGACCGTCGCGAGTTTCTGCT CTG

† Carrot Yellow Leaf Virus: due to the findings related to CYLV, an assay was designed for this virus and the related virus CUCV to allow further investigative work to be conducted.

1.2. Design and validation work

CtRLV and CtRLVaRNA

Two assays were designed for CtRLV using the twelve sequences available on NCBI (June 2012) and two assays for CtRLVaRNA using the eight sequences available on NCBI (June 2012). These assays were tested against positive control material from the Fera virus collection. The most sensitive assays were used for further work and are detailed in Table 4. The CtRLVaRNA assay was used to screen the metagenomic samples and was found to correctly identify a CtRLVaRNA positive sample that tested negative using the conventional assay used for the large-scale screening.

AYV

Two assays were designed for sequences of AYV obtained from Neil Boonham (Fera). These assays were used to screen ten of the cow parsley samples and ten of the hogweed samples. The same 30% of cow parsley was found to be positive with both assays. No AYV was found in the hogweed samples. One assay, detailed in Table 4, was chosen for further work.

PYFV

Two PYFV assays were designed for the one sequence of PYFV available on NCBI. Neither assay was able to detect PYFV in positive control material or in a range of PYFV assay-positive carrot samples obtained from the current study. It was the intention to design further assays using data obtained from the metagenomic study but no PYFV was detected. Towards the end of the project it was found that the conventional PYFV assay was

detecting a range of other viruses, so the material identified as positive by this assay and used to screen the new real-time assays was not positive for PYFV. When the assays were tested on a single weed sample confirmed to have PYFV by sequencing of the PCR product, both real-time assays were found to also detect this virus. Table 4 provides details of the sequences used in one of these assays. Due to the known high variability of PYFV and the lack of test samples found in the current study, there is no guarantee that this assay will universally detect other isolates of PYFV.

CMoV

Three assays were designed to cover the diversity of CMoV found in the nine sequences available on Genbank. These assays, together or singly, were unable to detect CMoV in positive control material or in a range of CMoV carrot samples obtained from the current study. A further assay was designed based on the results of the metagenomic analysis and this was able to correctly detect CMoV in a range of the metagenomic samples. Details of this assay are given in Table 4. This assay was specifically designed to detect CMoV sequenced during this study. CMoV is known to be particularly diverse so there is no guarantee that this assay will universally detect other isolates of CMoV.

2: Studies on incidence of CMD viruses in field weeds and carrot crops

Table 5. Summary of virus findings in the field weed samples. These results concentrate only on the CMD and PYFV testing. None of the weed samples tested were shown to be positive for Carrot Red Leaf-associated RNA.

Species	No. of fields sampled	No. of samples	CtRLV	CMoV	CtRLVaRNA	PYFV
Hogweed	9	58	1	1		1
Cow parsley	7	25	7			
Hemlock	1	1				
Rough chervil	2	3	1			
Total	9	87	9	1	0	1

Of the 87 samples collected as part of the weed study, only 12% were found to contain any virus. The highest virus incidence was CtRLV; PYFV was only found in a single hogweed sample. This is in contrast to the previous weed study (Morgan, 2004), which found 37% of cow parsley to be infected with PYFV. There were also relatively few findings of these viruses within carrot. Therefore, few conclusions can be drawn on the significance of weed hosts as infection reservoirs in the epidemiology of these viruses.

To put the findings from this study into a broader context, neighbour joining trees have been constructed (Figures 5 and 6) to show the relationships between isolates from these studies and published sequences from NCBI/Genbank. The clusters of sequence data from Carrot Red Leaf Virus-infected samples in Figure 5 show there is a broad split between sequences obtained from carrots and those from weeds, with only one carrot-positive in the 'weed cluster' and one weed-positive in the 'carrot cluster'. This would appear to broadly support the suggestion that different populations of CtRLV circulate in carrots and weed hosts (Dez Barbara, personal communication). However, due to the low numbers of samples sequenced, firm conclusions on the populations of CtRLV cannot be drawn at this time.

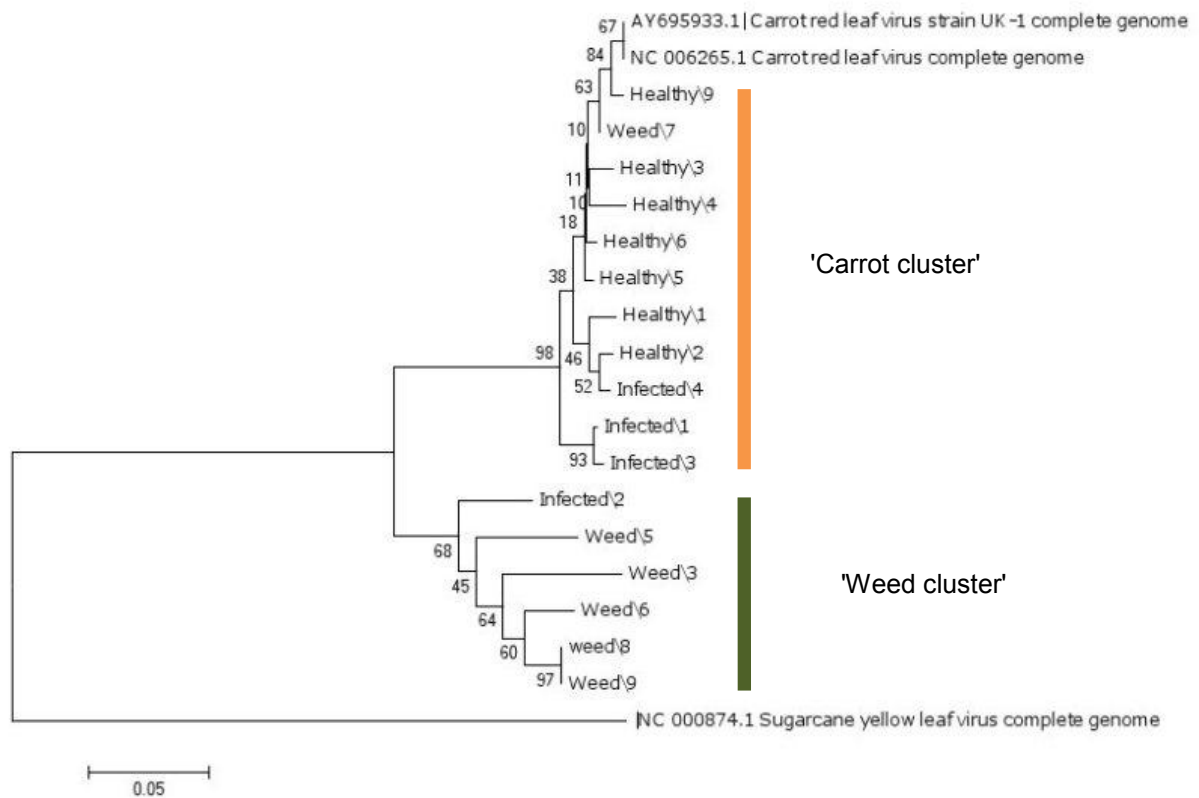

Figure 5. Carrot Red Leaf Virus' nearest neighbour joining tree. NCBI accessions of CtRLV and a related virus (Sugarcane Yellow Leaf Virus; ScYLV) are also shown for comparison. Note that 'healthy' = asymptomatic carrot; 'infected' = symptomatic carrot; weed = virus from a weed source.

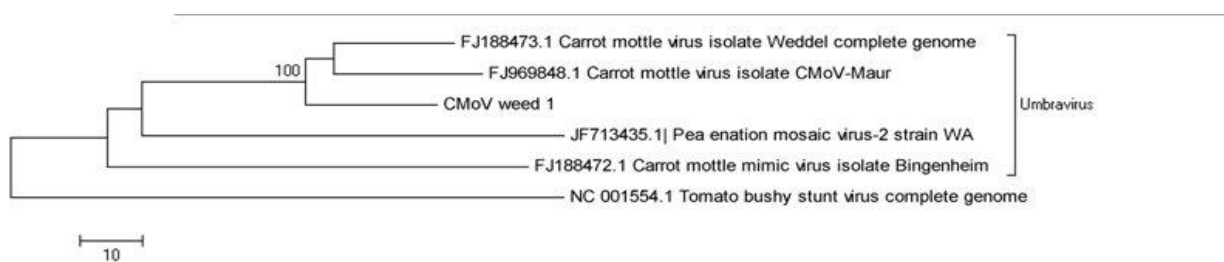

Figure 6. Carrot Mottle Virus nearest neighbour joining tree. Only one CMoV sequence was successfully obtained within this study.

3. The influence of viruses on the aetiology of internal browning

Figure 7. Examples of symptoms of infected carrot samples submitted as part of the 2012 survey. (a) Cross section of carrot root showing internal browning/necrosis. (b) Internal browning of carrot root. (c) External browning of the root tip.

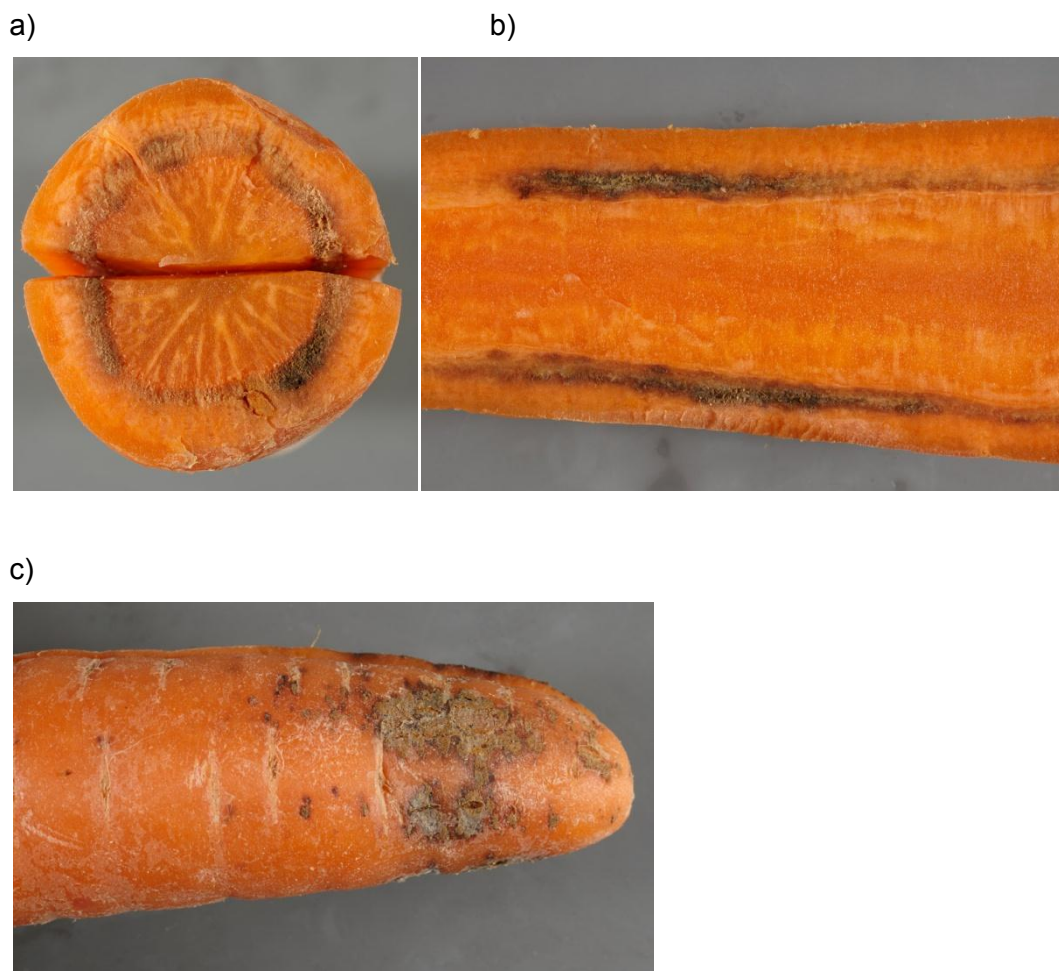

Figure 7. Examples of symptoms of infected carrot samples submitted as part of the 2012 survey. (a) Cross section of carrot root showing internal browning/necrosis. (b) Internal browning of carrot root. (c) External browning of the root tip.

3.1. Headline data on findings from affected/unaffected carrot samples

Carrots numbering 3330 from a field crop were examined in order to collect 102 necrotic carrots. Hence, the prevalence of necrosis (P[N]) was estimated to be 3.0% (95% confidence interval 2.5 to 3.7%). Each of the necrotic carrots and 99 non-necrotic carrots were tested for the presence of a number of viruses.

The carrot virus findings are presented as cases of virus in Table 6. A case of virus is a single virus result from a sample. A negative finding would be one negative case. A carrot root with a virus will be counted as one case of that virus. In the event of a mixed infection, this will be counted as one case of each virus present. For the statistical analysis, the influence of viruses was considered both as single infections and as co-infections.

The table in Appendix 2 gives the overall dataset for the statistical analysis of carrot virus incidence and the influence of these viruses on the presence of necrosis. The table includes estimates of the prevalence of viruses in necrotic and non-necrotic carrots, the prevalence of viruses in the carrot population, the prevalence of necrosis in infected and uninfected carrots and, finally, an estimate of the effect of removing virus on the prevalence of necrosis. The results presented here show the statistical correlation of CYLV with the presence of root necrosis. These data are presented graphically in Figures 8 and 9.

Table 6. Results from targeted virus testing following design of a specific assay for CYLV. Virus test results presented as cases of virus.

	Symptoms	
	Affected	Unaffected
No. tested	102	99
PYFV	2	6
CtRLV	33	27
CtRLVaRNA	0	0
CMoV	9	14
CYLV	99	22
Negative	2	47
Total positive carrots	100	52
Total cases	145	116
Mixed infections:		
CtRLV + CMoV		4
PYFV + CMoV		1
PYFV + CtRLV		1
PYFV + CYLV	1	
CtRLV + CYLV	27	7
CMoV + CYLV	3	
PYFV + CtRLV + CMoV		1
CtRLV + CMoV + CYLV	5	1
PYFV + CMoV + CYLV	1	
	43 Additional cases	17 Additional cases

Estimated prevalence of necrosis across all carrots (95% confidence interval)

Estimated prevalence of necrosis in virus-positive carrots (with 95% confidence interval)

Estimated prevalence of necrosis in virus-negative carrots (with 95% confidence interval)

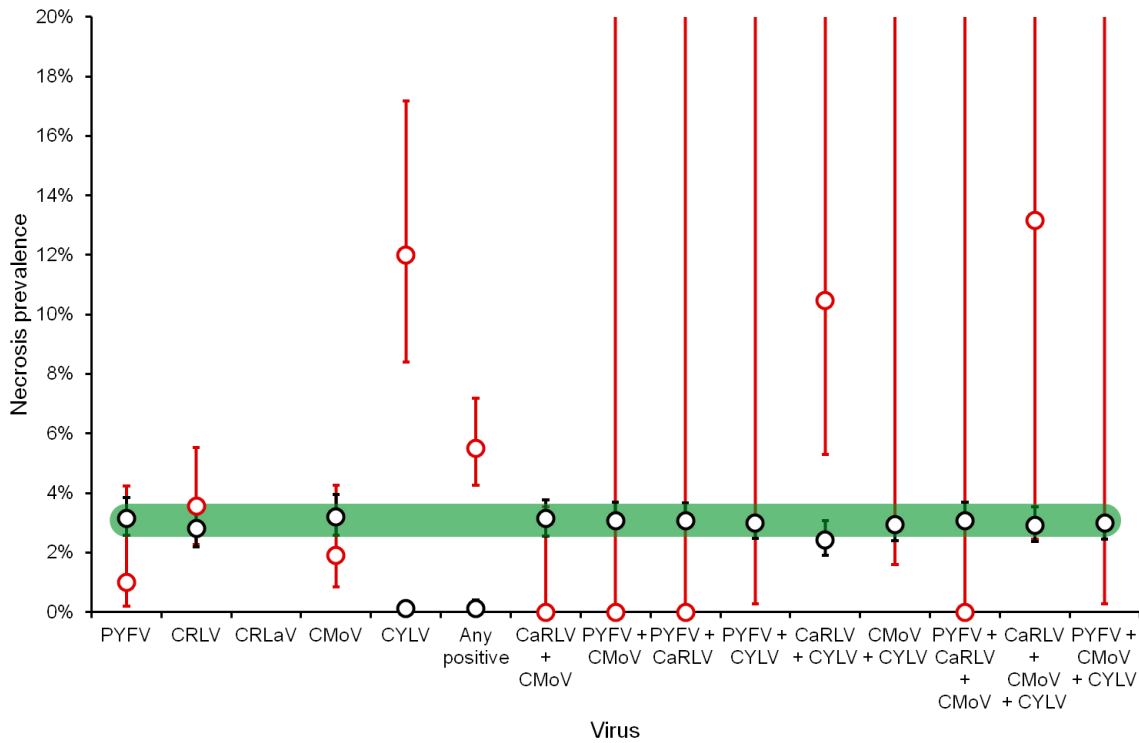

Figure 8: Prevalence of necrosis in virus-positive and virus-negative carrots. The green bar represents the estimated prevalence of necrosis across all carrots. The table of supporting calculations can be found in Appendix 2. Note that: CRLV or CaRLV = CtRLV; CRLaV = CtRLVaRNA

Figure 8 shows the prevalence of necrosis in virus-positive and virus-negative carrots. The black points show the incidence of symptom negative/virus positive roots. Through looking at the viruses present in asymptomatic carrots it can be determined that the CMD viruses and PYFV did not correlate with the presence of necrosis, indicating that these viruses were likely not to be associated with the presence of necrosis. By contrast CYLV, either singly or in combination with other viruses, associates strongly with the presence of necrosis and is estimated to be largely absent from asymptomatic carrots in the sampled population (estimated incidence 0.3%).

— No reduction

○ Estimated reduction in prevalence of necrosis associated with the removal of a virus (with 95% confidence interval)

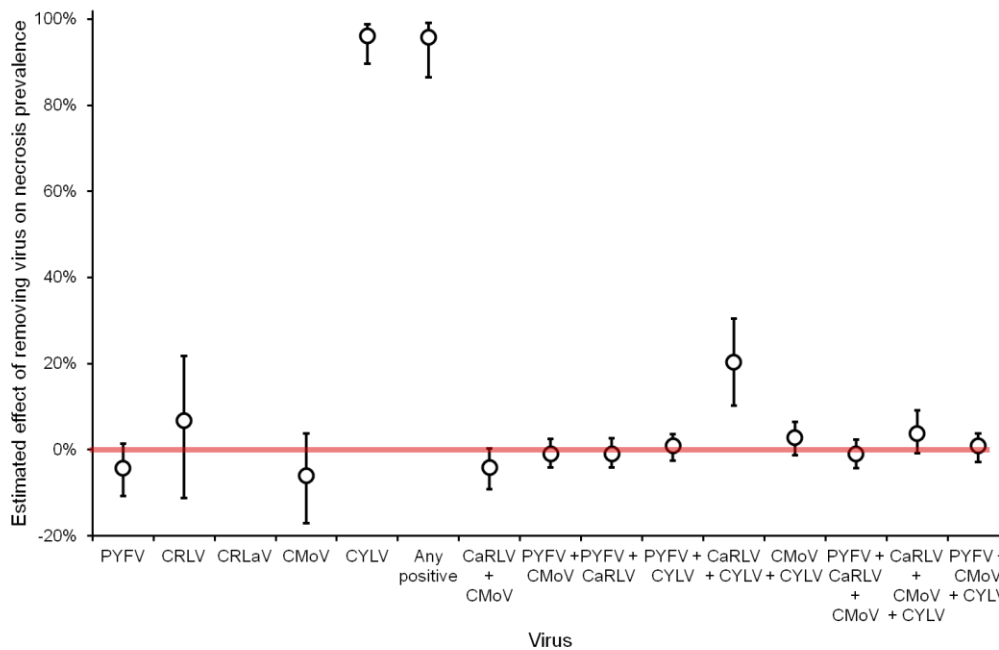

Figure 9. Estimated reduction in the prevalence of necrosis associated with the removal of a virus. Note: CRLV or CaRLV = CtRLV; CRLaV = CtRLVaRNA

The estimated reduction in necrosis prevalence (Equation 4) associated with the removal of a virus can be seen in Figure 9. Removing CYLV from the population is estimated to have the greatest effect, with an estimated reduction of 96% of necrosis. The supporting calculations for this figure can be found in Appendix 2.

With one exception (CYLV), there is no association between virus status and the prevalence of necrosis; the estimated prevalence of necrosis is not affected by virus status (Figure 8). However, CYLV-positive carrots have an estimated prevalence of necrosis of 12.0% (8.4–17.1%), while the prevalence of necrosis in CYLV-negative carrots is estimated to be 0.1% (0.0–0.3%). The effect of CYLV is also seen when combinations of viruses including CYLV are considered.

Because necrosis *without* CYLV is estimated to be rare (0.0–0.3%) the removal of CYLV may be sufficient to greatly reduce the prevalence of necrosis if CYLV is indeed causative. Removal of CYLV is estimated to potentially reduce necrosis by 96.1% (89.6–98.8%).

3.2. Metagenomics

Individually indexed DNA libraries were made from RNA extracted from 24 carrot samples, both with and without symptoms of necrosis. The origins of the samples are detailed in Table 3. The libraries were run on two MiSeq flow cells yielding 1×10^{10} bp of DNA sequence. After assembly, the sequences were compared to the NCBI Genbank database using BLASTX. Figure 10 shows the taxonomic assignment of these BLAST results using the software package MEGAN.

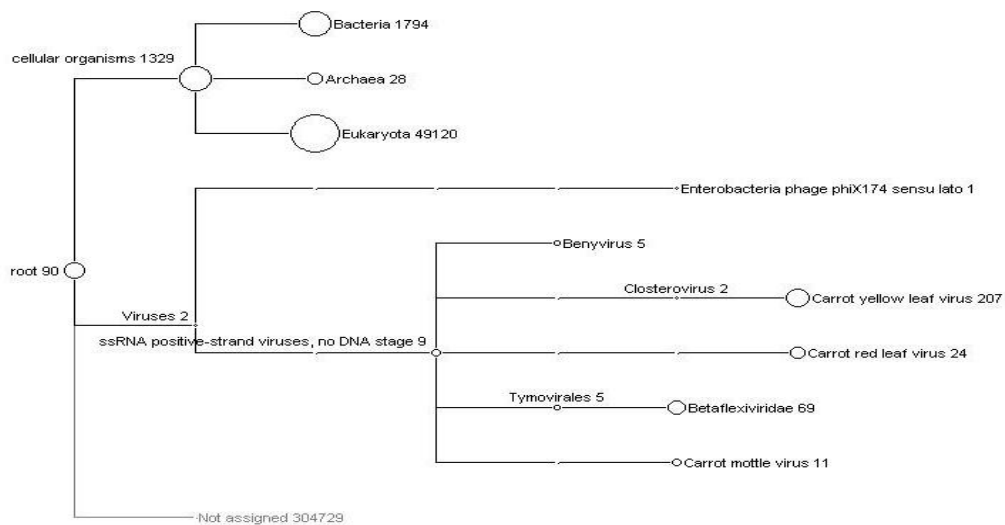

a

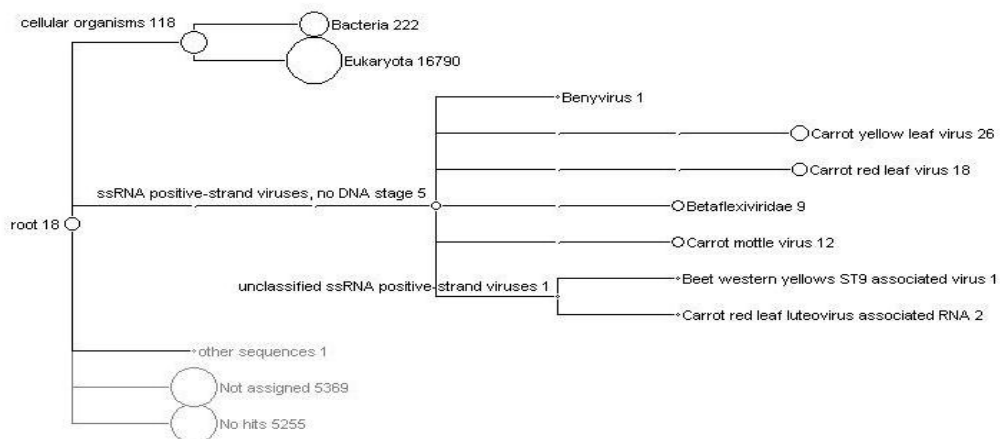

Figure 10. Phylogram of taxa identified in (a) symptomatic and (b) non symptomatic carrots. Numbers represent number of contigs identified, not total number of reads.

All samples contained bacterial, fungal, plant and virus-related sequences. The most prevalent virus in the symptomatic samples was CYLV, for which complete genomes were recovered. These samples also contained complete or almost complete genomes of CMoV, CtRLV, a novel Torrado-like virus and up to seven related novel Betaflexiviruses identified as *Betaflexiviridae* and *Tymovirales*. One sample also contained the complete genome of a *Closterovirus* closely related to CYLV. Fragments of a novel *Benyvirus* were also found. The PhiX bacteriophage detected was spiked into the sample as a positive control.

Some CYLV was detected in the non-symptomatic samples along with CtRLV, CtMoV and CtRLVaRNA.

Due to its high incidence in symptomatic carrots and lower incidence in unaffected carrots, CYLV was chosen for initial further study (see Figure 12). A TaqMan[®] assay was designed for this virus (details in Table 4), the use of which is detailed in the following section.

A second related virus, called Carrot Unclassified Closterovirus (CUCV) for the purposes of this study, was also examined due to its similarity to CYLV. This virus appears to be a *Closterovirus* most closely related to CYLV. The complete genomes of CYLV and CUCV are 63% homologous. Figure 11 shows a phylogenetic tree of the coat proteins of CUCV and other related Closteroviruses. This confirms it as a member of the genus *Closterovirus*.

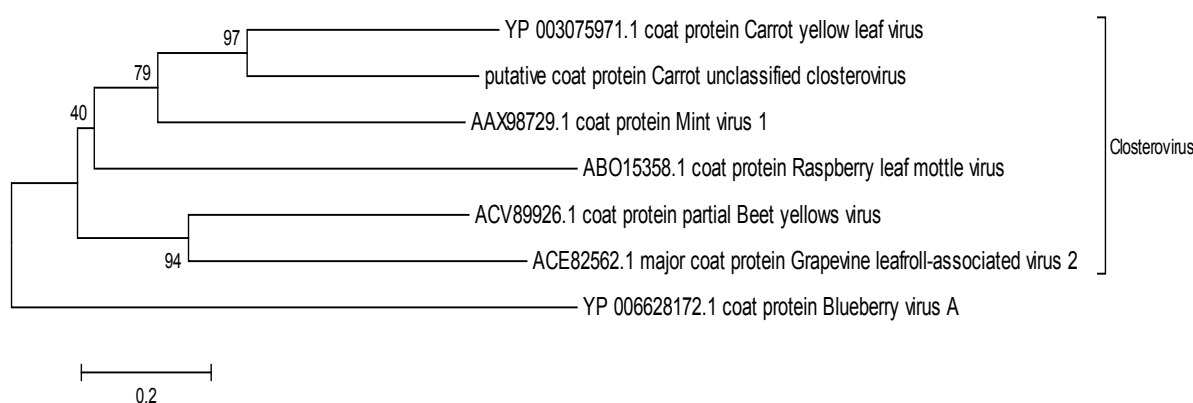

Figure 11. Phylogenetic tree of coat protein sequences of CUCV, CYLV and other related viruses. GenBank accession numbers are shown.

A TaqMan[®] assay was designed to identify CUCV and potentially distinguish it from CYLV. This assay is detailed in Table 4.

At least nine other viruses were detected in the carrots. Due to time and budget considerations, these viruses have yet to be fully analysed or their significance determined.

4. Additional work carried out investigating the presence of Carrot Yellow Leaf Virus and other novel virus sequences

A real-time PCR assay was designed to screen samples for the presence of CYLV and was initially used to retest the 24 samples sequenced using NGS. Figure 12 shows the results of these assays. High levels of CYLV were found in eleven of twelve of the symptomatic samples but only in one of twelve of the healthy samples. The twelve necrotic samples were further screened with the CUCV assay and this virus was only found in sample S3. The low levels of CYLV in sample S3 may be due to low levels of CYLV or a cross reaction between the assays for CYLV and CUCV.

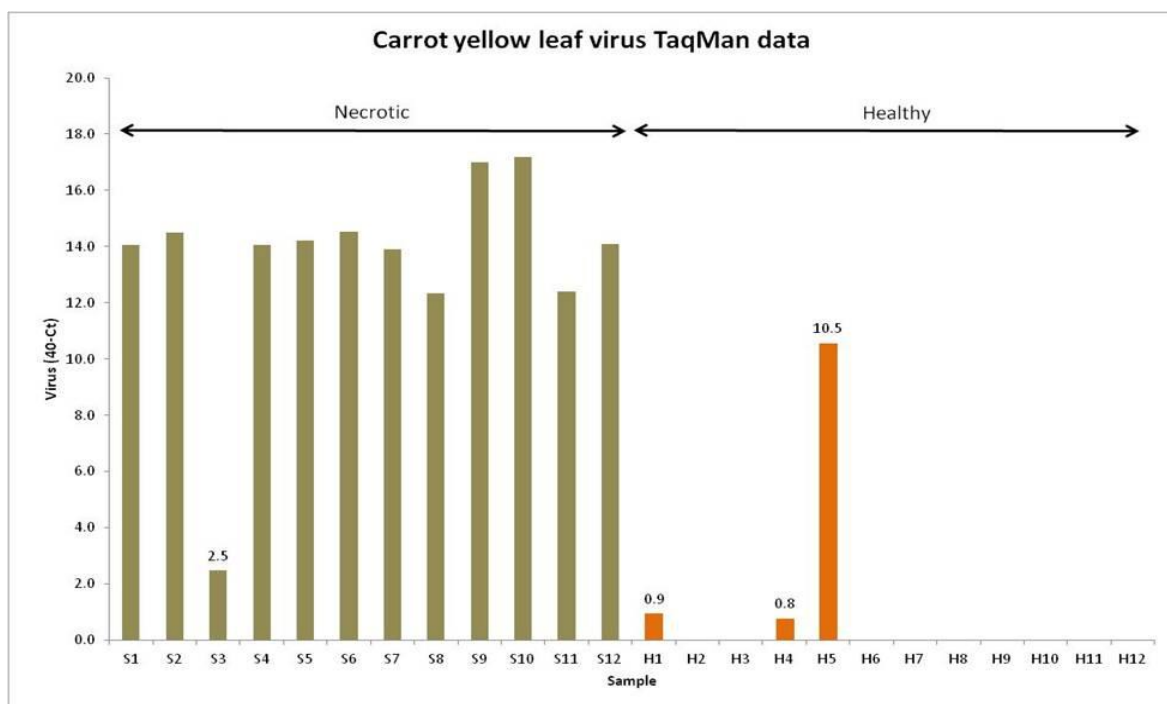

Figure 12. Results of initial real-time PCR confirmation testing of presence of CYLV in the carrot sub-sample, which had been tested using next-generation sequencing.

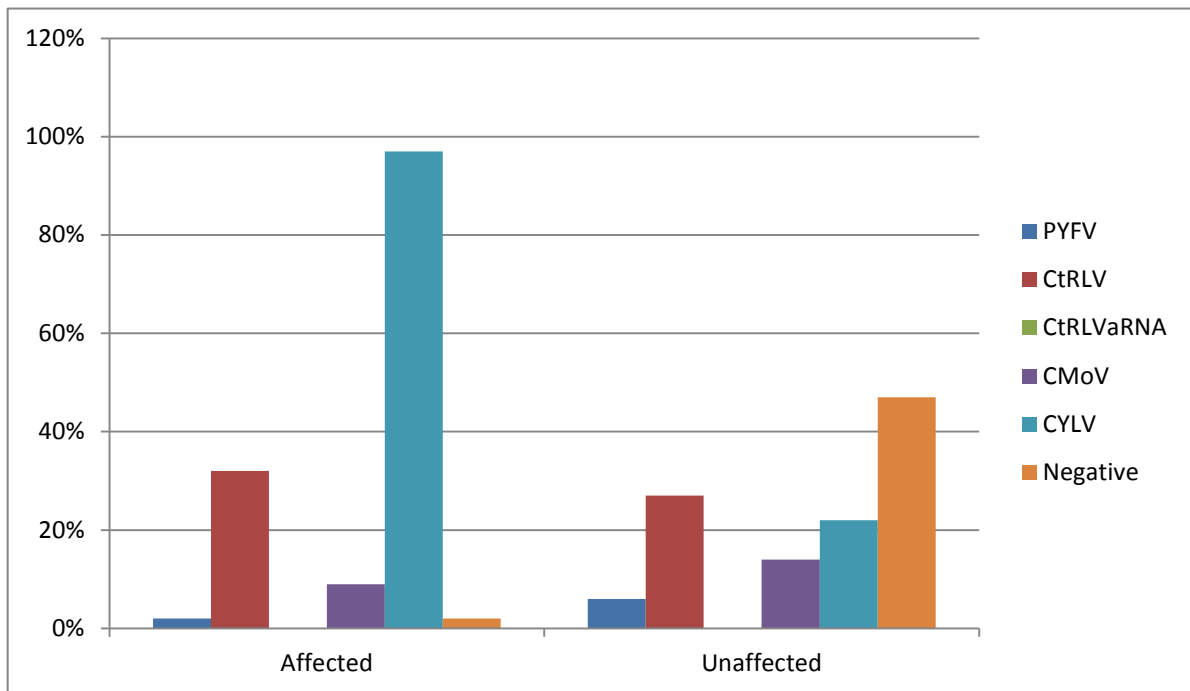

Figure 13. Results from testing total field sample of 102 affected and 99 unaffected carrots for the presence of carrot viruses, presented as a percentage of carrots with browning symptoms (affected) and without browning symptoms (unaffected) where virus was detected by PCR or TaqMan®.

The assay for CYLV was then used to screen the 102 affected and 99 unaffected samples shown in Figure 13. The relatively consistent incidence of CtRLV between affected and unaffected carrots contrasts with the high incidence of CYLV present in affected carrots and the low level of CYLV in unaffected carrots. These data formed the basis of the statistical analysis detailed earlier in this section.

Discussion

The overall aim of this work was to determine the viral pathogens that are influencing the development of internal necrosis leading to browning either on the root surface or within the root cortex around the central core. To achieve this, the project was divided into three main sections: developing efficient diagnostics; investigating sources of carrot viruses; and investigating the influence of carrot viruses on the incidence of necrotic root symptoms. The broad aim has been successfully achieved, though with a somewhat unexpected result given the virus now linked to the symptom is not one of the viruses initially proposed for investigation through this project.

Development of new diagnostic assays

Designing real-time PCR diagnostic assays for the established carrot viruses Parsnip Yellow Fleck Virus (PYFV) and the Carrot Motley Dwarf (CMD) complex, fulfils a need to have cost-effective diagnostic solutions to support the carrot industry and associated research. Prior to this work, conventional PCR was the primary diagnostic tool for these virus targets. Whilst conventional PCR does have advantages of sensitivity and cost of development, its main advantage is that PCR products can subsequently be used for sequence analysis. However, for use in routine diagnostics these advantages are outweighed by the need for repeated liquid handling; opening and closing of sample tubes; and the multiple steps needed to obtain and interpret results, including running of samples on agarose gels and interpreting results by observation of gel photographs. Developing real-time diagnostics brings the advantages of a system where samples can be set up using automated robotics, sample extracts are then sealed for running and results are interpreted through the emission of fluorescent light during the diagnostic reaction. This, in turn, leads to automated result interpretation and increased sensitivity and speed of testing over conventional PCR methods, which further leads to more rapid, cheaper diagnostic solutions.

Initially, the assays that were designed for use within this project had been planned from previous work, but were untested. The initial objective was to validate these primer/probe sets for further use. The assay validation component of the project had mixed success, with best results coming from the assays for the CMD complex. However, initial validation testing showed that it was necessary to redesign these assays to obtain the best possible coverage of known isolates of CtRLV, CMoV and CtRLVaRNA. The greatest challenge in this work was designing an assay for PYFV. There are few published sequences for this virus on NCBI/Genbank, and so much of the sequence data used for initial assay design originated from the PYFV samples sequenced as part of project FV 228a (Morgan, 2004). Because of

the variability of this virus, a single primer set assay to detect a range of PYFV isolates remains elusive. Additionally, following the next-generation sequencing (NGS) work, an assay was designed for CYLV, which, although not fully validated, has been broadly checked through testing the field carrot samples in support of statistical modelling. The assays for CMD and CYLV will now be made available to the carrot industry through the Fera Plant Clinic. Validation of these real-time PCR assays is still on-going with any new samples received.

The other major diagnostic development within this project has been the confirmation of the potential for next-generation sequencing to be applied to general diagnostic applications in plant pathology. The technologies to carry out this type of work are rapidly reducing in cost, and are quickly becoming comparable to the costs of testing single samples with multiple PCR assays. The major challenge in applying this technology is in streamlining the bioinformatics used to sift and interpret the many millions of fragments of genetic sequence data produced by the sequencing machine. Through this project, two approaches to overcoming this challenge have been followed. 'Open-ended' searching involves looking for any possible sequence that may have a pathogenic origin; this was the primary searching method for finding novel or unexpected targets and led to the findings of CYLV. Alternatively, 'targeted searching' involves looking for known pathogen sequences. Because searches are restricted to using known sequence data, this allows a more rapid interpretation of the sequence dataset. This would allow NGS technology to be applied far more readily to traditional diagnostic applications. Within this study, this latter approach was used for checking NGS data for the presence of the expected carrot viruses as part of validating the new assays and also checking for any isolates of CMD or PYFV that may have been missed in routine testing.

Incidence of carrot viruses in field weeds and carrot crops

The most surprising aspect of the field weed sampling was the apparent lack of findings of the established carrot viruses. Previous studies (Morgan, 2004) had indicated a prevalence of PYFV around carrot fields of around 40%, yet only one weed sample and eight of the 200 carrots tested were found to contain this virus. Carrot Red Leaf Virus was found at a higher incidence in around 28% of weed samples and approximately 30% of carrots tested. It is possible that this is a consequence of the localised aspect of the sampling regime in this study, with a focus on a few fields known to be associated with necrosis, whereas the previous study focused on PYFV associated fields. The difference could also potentially be a consequence of changes in agronomy practice in the decade since the PYFV study was conducted. In the last few years there has been an adoption of new insecticidal chemistries

(e.g. neonicotinoids) that could inadvertently be driving differential epidemiologies of a range of viruses and acting to suppress some viruses more than others. Biscaya (thiacloprid) has been used as a spray in last few years and has helped to add to our depleted armoury of insecticides, but does not appear to have had a major influence on virus levels in weeds or the crop. Neonicotinoid seed dressing (thiomethoxan formulated as "Cruiser") is only just starting to be used in carrots this year, with around 10–20% of crops treated, so its effect on virus reservoirs is yet to be shown. As carrots are a non-flowering crop, they should not be directly covered by a ban on this group of pesticides. If more widespread use of seed treatments happens, it is thought this could help with early virus control, but later control will still rely on insecticide spray treatments.

The work conducted by the late Dez Barbara suggested that CMD was circulating within carrots, moving from previous season carrots under straw into new season plantings (Dez Barbara, personal communication). There is some evidence to support these conclusions from the CtRLV dataset within this study (Figure 5). Unfortunately, as a consequence of low numbers of findings of the other viruses, no firm inferences can be drawn as to the epidemiology of other carrot virus.

Due to the nature of rotating crops, weed samples were collected from fields where carrots had been previously grown, and were known to be linked to the presence of necrosis. This means ultimately that there is not a direct association between the viruses from carrot samples and weed samples within this study.

As a consequence of the additional work carried out investigating the NGS findings of CYLV in affected and unaffected carrots, there was not the scope within the project to also examine the presence of CYLV in the weed samples. Additionally, the real-time PCR test used to determine the presence or absence of CYLV will only be of limited value in studying the viral populations of this virus, as real-time PCR product is not suitable for sequence analysis and a conventional PCR based solution will have to be pursued to conduct this work. Therefore, further work will be required to study the phylogenetics of CYLV and to investigate sources of the virus.

Viral causes of internal browning

Studies such as this one usually focus on the growing crop and attempt to trace infected individuals through a growing season to observe symptom development. However, given the relatively low numbers of affected carrot roots and the weak association with viral infection based on observing virus symptoms in foliage, taking such an approach would be

futile. The statistical model was therefore designed to allow a skewed sampling regime at the point of symptoms being observed; in this case in the processing line or pack-house.

The two groups of carrots sampled, i.e. those affected by symptoms and unaffected individuals, showed very little evidence of PYFV, as did the weed samples. This, in itself, shows differences to earlier studies on PYFV (Morgan, 2004) where 31% of carrots from affected fields were found to be positive for this virus (4% from this study), 37% of cow parsley, and 47% of rough chervil (1.6% in hogweed only from this study) were positive. One difference between these studies that may account for this difference is the skew in the sampling focus between the two studies. HDC project FV 228a (Morgan, 2004) was partially focused on samples that had been submitted with foliar symptoms, as was the symptomatic survey that precedes this study (Fox, 2011). By contrast, this study began from the end point of symptomatic carrot roots. In addition, the relatively even distribution of the CMD complex viruses CtRLV and CMoV between the affected and unaffected carrots (approximately 30% and 10% respectively) suggested that these viruses were unlikely to be linked to necrotic symptoms; a supposition supported by later statistical analysis. The fundamental key in this work was investigating the presence of virus in unaffected carrots and comparing this to the viruses in affected roots; previous studies have focused on the symptom, which has led to erroneous conclusions on the causes of internal necrosis.

The previous symptomatic survey raised the possibility that an as yet unidentified pathogen was involved in inducing necrotic root symptoms (Fox, 2011). Of the 30 or so viruses known to have carrot as a host, at least twelve are known to be present in the UK. However, these viruses are not amongst those regularly detected or investigated by diagnostic labs, either due to unknown prevalence, poor symptomatic recognition, or more commonly, poor availability of targeted diagnostics. The major diagnostics technologies currently utilised within laboratories are based upon detection of specific targets. This, in itself, can lead to a skewing of results and conclusions due to looking for only that which is already known. NGS applied in this respect gave an appropriate tool to screen carrots from the study for as yet unidentified viruses.

The data obtained from NGS showed that CYLV was present in all twelve of the affected sub-sample. One of these individuals was found to have a much lower number of sequence reads of this virus; this was taken to be a broad measure of virus concentration present in the sample. However, in this carrot, a novel virus of great similarity to CYLV was also found (CUCV). By contrast, only three of the unaffected carrots were found to contain sequences of CYLV, and in two of these this was only at very low levels. This clearly indicated a

potential link between this unexpected virus finding and the presence of necrosis. Two different methods of screening the sequence dataset were applied, using open-ended searches to look for novel viruses, and targeted searches to look for the expected viruses. The established viruses found within these samples did not correlate exactly with those detected using traditional diagnostic approaches. This is not an uncommon occurrence in early validation work when using new technologies and is thought to have been due to a bias in the extraction method used to create the sequence sample preparations. Investigations are on-going to optimise this technology for this type of investigation. In addition to these findings there were at least nine other novel viruses present within these samples and work is on-going to characterise these. One of the unknowns, CUCV, shows great similarity to CYLV; one other novel virus appears to have sequence similarity to the 'torrado' group of plant viruses. This is a potentially interesting finding, as members of this group have thus far only been found affecting solanaceous crops. However, further characterisation work is needed to draw conclusions about the potential effects and importance of these viruses.

Following these outcomes, CYLV was investigated further. A new CYLV real-time PCR assay was designed and was used to test the 102 affected and 99 unaffected carrots used within the statistical analysis of the potential viral causes of internal necrosis. The crop of carrots sampled showing 3% of necrotic symptoms (i.e. 3300 carrots) was sliced to obtain 100 symptomatic samples. Some of these carrots had surface necrosis that could have been graded out; others had only internal necrosis, and there were also carrots sampled with a combination of internal and external symptoms with approximately even numbers of each within the sample set.

A calculated 54% of carrots in the sampled population contained viral infections, with virus being present in 98% of affected carrots tested and in 52.5% of the asymptomatic carrots, suggesting that the presence of necrosis was not solely due to the presence of any of the viruses. CtRLV was calculated as being present in 32.4% affected and 27.3% non-affected carrot roots tested. This gave the highest incidence of any single virus present in 27.4% of carrot roots tested, but did not correlate with the presence of necrosis (See Appendix 2). Carrot Mottle Virus was present in nearly twice as many non-necrotic carrot roots as necrotic ones. This, in itself, suggested a clear difference in the obtained results from those in FV 382 (Fox, 2011). CYLV was found to be present in 97% of roots affected by necrosis and in 22% of the unaffected roots giving an incidence of virus in the sampled field population of 24.5%, and an estimated 12% of these carrots were exhibiting necrosis. This virus, either singly or in combination, gave the strongest correlation with observable

symptoms. If CYLV is the causal pathogen of carrot internal necrosis, removing CYLV from the sampled carrot population would give an estimated effect of reducing the incidence of necrosis by 96%. The statistical model demonstrated here can be applied to other situations where a disease of unknown cause is observed; this will be of particular use when applied to diseases thought to be caused by obligate pathogens such as viruses, viroids, phytoplasmas, or fungal obligates such as rusts or powdery and downy mildews.

The CYLV assay used has not been validated for use as a quantitative test, so definitive conclusions regarding test results and concentrations of virus cannot be reliably drawn. However, the high proportion of weak positives for CYLV in unaffected carrots could suggest that the CYLV-positive unaffected carrots may have been the result of late season infections and had not been infected for a sufficient period of time for symptoms to develop (eight out of 22 asymptomatic/CYLV-positive carrots).

Further work

There are several areas that need further investigation to confirm the findings of this report, including an empirical demonstration of CYLV inducing necrosis in a healthy, artificially inoculated carrot host. The experimental work required for this is currently on-going, with infected carrot samples being used to inoculate experimental host plants as the first stage in this process. The issue of carrot necrosis at present seems limited to a few growers and this aspect of the disease requires further investigation. In some part, this could be due to under reporting of the issue by growers. For the purposes of focusing on the issue of necrosis, this study was intentionally restricted to a tight geographic area within the Vale of York, as this was the area from which symptomatic samples were most commonly submitted to the laboratory for diagnostic testing. This gives rise to the possibility that geographic factors within this region could be influencing the development of necrosis. No inferences can be made regarding the incidence of CYLV, or other carrot viruses, on a local, regional or national level. For instance, there is a possibility that CYLV only occurs within the locality sampled. However, this is unlikely given that this is an aphid-transmitted virus and the other UK finding, in the guise of Hogweed 6 Virus, originated near Dundee in Scotland (Bem and Murrant, 1979a). Similarly, localised environmental conditions may be a contributing factor, pre-disposing carrot roots to symptom development. However, this is also unlikely. Other potential reasons for this localised reporting may be the agronomic factors within these specific crops. Within other crops there are recognised varietal influences upon symptom development resulting from viral infections. In the case of a viral internal necrosis, this is most widely studied with spraing disease of potato where varietal tolerance of Tobacco Rattle Virus is now recognised (Dale and Neilson, 2006). The carrots within this study were

all of the Nairobi cultivar, and as this tends to be the variety seen with this symptom it is possible that this variety could be particularly susceptible to necrosis. Additionally, other agronomic factors may play a role in symptom development, for example, length of time in the ground, timing of infection, and irrigation timings could all contribute to pre-disposing crops to symptom development.

The benefit of having an identity for the causal pathogen is that management options can now be explored to look at the most appropriate ways of achieving a reduction in necrosis in affected areas. As little is known about this particular virus and its importance in UK carrot horticulture, the next step is to investigate the key aspects of designing an effective management regime. This would include:

- **Demonstration of Koch's Postulates:** Whilst Koch's Postulates cannot be demonstrated in their strictest sense, the principles can be applied and the same degree of rigour applied to the interpretation of further investigations into the causal relationship between CYLV and root necrosis. Demonstrating a mathematical relationship only shows a correlation between pathogen and symptom. CYLV isolates collected within this study will be inoculated onto alternate host plants and then inoculated back into healthy carrots with the aim of inducing symptom development under experimental conditions. As part of the virus characterisation work, symptoms will be recorded to look for potential differences between CYLV and the established carrot viruses.
- **Field transmission of CYLV:** The carrot aphid (*Cavariella aegopodii*) and the parsnip aphid (*C. pastinaceae*) are both reported as vectors of the pathogen. Fera has a good track record of investigating transmission of aphid-transmitted viruses through laboratory and field studies on both the timing and efficiency of transmission, including offering an on-going monitoring service for aphid vectors that could be extended into the carrot industry. This could lead to the development of a predictive model for infection and disease development. Important factors to consider within this work are:
 - **Timing of transmission:** When in the season do the aphids pick up CYLV? This will help determine whether insecticide treatment regimes can be tailored. Potentially, this could be linked to direct testing within the aphids.
 - **Weeds as hosts for CYLV –** to investigate the importance of different virus sources that are key in the transmission of CYLV: There are two main

models for the circulation of carrot viruses, either: weed hosts (e.g. PYFV) but not necessarily with a helper virus; or carrot reservoirs (e.g. CMD). By working out the routes of transmission, treatment regimes can be better focused against different viruses.

- Time lapse from transmission to internal symptom expression: If there is an extended period from infection to symptom development, early warning systems based on crop monitoring and early diagnosis could help minimise the impact in affected crops by enabling growers to lift affected crops earlier than non-infected crops.

Conclusions

The overall aim of the project was to investigate viral causes of carrot root necrosis. This issue had been known and recognised since before the inception of the PYFV project (Morgan, 2004), but successive projects had been unable to find a definitive viral link.

- The outcomes of this work show that, although potentially damaging to carrots in terms of lowering yield and causing growth defects, infection by the four established carrot viruses did not correlate with internal necrosis.
- PYFV was found at a lower incidence than expected. This could be due to changes in prevalent insecticidal chemistries used for management of virus vector aphids.
- There is evidence to support the suggestion that CtRLV circulating in carrots may largely originate in carrot crops rather than from weed sources.
- This work firmly links the presence of internal necrosis to infection with CYLV. This is a new symptom associated with this little-studied virus. Work is on-going to demonstrate Koch's Postulates for development of this particular symptom in carrot roots and to begin investigations on some of the other novel viruses found within this study.

Knowledge and technology transfer

Due to the single year nature of this project, no technology or knowledge transfer (KT) has yet taken place.

- It is intended that the outcomes of this work will be published in an appropriate scientific journal.
- KT activities will take place under the auspices of the HDC and BCGA including talks to growers' meetings.

- The findings will also be disseminated through the Fera Plant Clinic News.
- The assays designed within this project will be offered to growers through the Fera Plant Clinic.

Glossary

Contigs	Short sections of sequence data that are constructed from the products of sequencing reactions to allow sequence identity to be confirmed.
<i>In silico</i>	A study carried out using a computer-based technology. A modern extension of <i>in vivo</i> , <i>in vitro</i> , <i>in planta</i> ...
Metagenomics	The application of next-generation sequencing and bioinformatics.
Necrosis	Cell death. In this context, localised cell death leading to a brown, often corky symptom. This may be superficial/surface lesions or may extend through the parenchyma tissue surrounding the core of the carrot root.
Next generation sequencing (NGS)	A non-targeted approach to identification. Total nucleic acids are extracted from a sample and analysed against the Genbank database to look for matches and near matches. This allows unknown targets to be identified.
Obligate pathogen	A pathogen that cannot be cultured on artificial media in the laboratory. This includes pathogens such as viruses, viroids and phytoplasmas. Specialised technologies and techniques are required to detect and diagnose these pathogens.
PCR	Polymerase Chain Reaction. A molecular diagnostic technology using specific primer sets to detect target pathogens.
Primer	As used in PCR, short sections of nucleic acid that are complementary to target DNA or RNA sequences. These then bind to target nucleic acid and replicate the target sequence to detectable quantities.

Real-time PCR	A development of PCR based on fluorescent chemistry. This brings advantages of sensitivity and amenability to high throughput, lowering costs of testing.
RNA	Ribonucleic Acid. A single strand form of nucleic acid. The majority of plant viruses are RNA not DNA based.
Sequence	Analysed sections of DNA or RNA. These can be used to compare against existing published sequence data to identify target pathogens.

References

Adams, I.P., Glover, R.H., Monger, W.A., Mumford, R., Jackeviciene, E., Navalinskiene, M., Samuitiene, M. and Boonham, N. (2009). Next-generation sequencing and metagenomic analysis: a universal diagnostic tool in plant virology. *Molecular Plant Pathology* 10: 537–545.

Adams, I.P., Miano, D.W., Kinyua, Z.M., Wangai, A., Kimani, E., Phiri' N., Reeder, R., Harju, V., Glover, R., Hany, U., Souza-Richards, R., Deb Nath, P., Nixon, T., Fox, A., Barnes, A., Smith, J., Skelton, A., Thwaites, R., Mumford, R. and Boonham, N. (2012). Use of next-generation sequencing for the identification and characterization of Maize Chlorotic Mottle Virus and Sugarcane Mosaic Virus causing Maize Lethal Necrosis in Kenya. *Plant Pathology* [DOI: 10.1111/j.1365-3059.2012.02690.x] (Currently available through online preview).

Bem, F. and Murrant, A.F. (1979a). Transmission and differentiation of six viruses infecting hogweed (*Heracleum sphondylium*) in Scotland. *Annals of Applied Biology* 92(2): 237–242.

Bem, F. and Murrant, A.F. (1979b). Host range, purification and serological properties of Heracleum Latent Virus. *Annals of Applied Biology* 92(2): 243–256

Benson, D.A., Karsch-Mizrachi, I., Lipman, D.J., Ostell, J., Sayers, E.W., (2011). GenBank. *Nucleic Acids Research* 39: D32–7.

Boonham, N., Smith, P., Walsh, K., Tame, J., Morris, J., Spence, N., Bennison, J. and Barker, I. (2002). The detection of Tomato Spotted Wilt Virus (TSWV) in individual thrips vectors using real-time fluorescent RT-PCR (TaqMan®). *Journal of Virological Methods*, 101: 37–48.

Boonham, N., Gonzalez-Pérez, L., Mendez, M.S., Lilia-Perata, E., Blockley, A., Walsh, K., Barker, I. and Mumford, R.A. (2004). Development of real-time RT-PCR assay for the detection of potato spindle tuber viroid. *Journal of Virological Methods*, 116: 139–146.

Camacho, C., Coulouris, G. and Avagyan, V., (2009). BLAST+: architecture and applications. *BMC Bioinformatics* 10: 421.

Dale, F. and Neilson, R. (2006). Free-living nematodes and spraing. *The Potato Council Research Review* R276: 53–54.

Descriptions of plant viruses (2003). Cucumber Mosaic Virus, DPV 213.

EPPO/OEPP (2010) PM 7/98 (1): Specific requirements for laboratories preparing accreditation for a plant pest diagnostic activity, *EPPO Bulletin* 40(1): 5–22.

Fredericks, D.N. and Relman, D.A. (1996). Sequence-based identification of microbial pathogens: a reconsideration of Koch's Postulates. *Clinical Microbiology Reviews* 9(1): 18–33.

Fox, A. (2011). Symptomatic survey of virus complexes of carrot. *Horticultural Development Company final report for project FV 382*.

Grabherr, M., Hass, B. and Regev, A. (2011). Full-length transcriptome assembly from RNA-Seq data without a reference genome. *Nature Biotechnology* 29: 644–652.

Harju, V., Skelton, A., Forde, S., Bennett, S., Glover, R., Monger, W., Adams, I., Boonham, N. and Fox, A. (2012). New virus detected on *Nasturtium officinale* (watercress), *New Disease Reports* 25: 1, [<http://dx.doi.org/10.5197/j.2044-0588.2012.025.001>].

Huson, D.H., Auch, A.F., Qi, J. and Schuster, S.C. (2007). MEGAN analysis of metagenomic data. *Genome Research* 17: 377–86.

International committee on taxonomy of viruses (ICTV), (2012). <http://www.ictvonline.org/virusTaxonomy.asp>

Korimbocus, J., Danks, C., Boonham, N., Barker, I. and Coates, D. (2002). Improved detection of Sugarcane Yellow Leaf Virus using a real-time fluorescent (TaqMan[®]) RT-PCR assay. *Journal of Virological Methods* 103: 109–120.

Morgan, D. (2004). Parsnip Yellow Fleck Virus: Development of a disease management strategy. *Horticultural Development Company/HortLINK final report for project FV 228a/HL0194*.

Mumford, R.A., Walsh, K., Barker, I. and Boonham, N. (2000). Detection of Potato Mop Top Virus and Tobacco Rattle Virus using a multiplex real-time fluorescent reverse-transcription polymerase chain reaction assay. *Phytopathology* 90(5): 448–453.

Mumford, R., Skelton, A., Metcalfe, E., Walsh, K. and Boonham, N. (2004). The reliable detection of Barley Yellow and Mild Mosaic Viruses using real-time PCR (TaqMan®). *Journal of Virological Methods* 117: 153–159.

Pemberton, A.W. and Frost, R.R. (1974). Celery Mosaic Virus in England. *Plant Pathology* 23: 20–24.

Appendices

Appendix 1

Table 7. Location of field weed samples collected and tested by PCR for virus.

Sample Number	Species Sample type	Date sampled	Field	Postcode	Grid Ref.
1	Hogweed	23/7/12	4	YO42	SE 74301 48126
2	Hogweed	23/7/12	5	YO42	SE 73987 48206
3	Hemlock	23/7/12	6	YO42	SE 74270 48331
4	Hogweed	23/7/12	2	YO42	SE 73972 47615
5	Cow parsley	23/7/12	3	YO42	SE 74185 47680
6	Cow parsley	23/7/12	2	YO42	SE 73972 47615
7	Hogweed	23/7/12	3	YO42	SE 74185 47680
8	Hogweed	23/7/12	5	YO42	SE 73987 48206
9	Cow parsley	23/7/12	6	YO42	SE 74270 48331
10	Hogweed	23/7/12	5	YO42	SE 73987 48206
11	Cow parsley	23/7/12	6	YO42	SE 74270 48331
12	Cow parsley	23/7/12	4	YO42	SE 74301 48126
13	Cow parsley	23/7/12	4	YO42	SE 74301 48126
14	Cow parsley	23/7/12	6	YO42	SE 74270 48331
15	Cow parsley	23/7/12	2	YO42	SE 73972 47615
16	Hogweed	23/7/12	2	YO42	SE 73972 47615
17	Hogweed	23/7/12	5	YO42	SE 73987 48206
18	Hogweed	23/7/12	3	YO42	SE 74185 47680
19	Cow parsley	23/7/12	4	YO42	SE 74301 48126
20	Hogweed	23/7/12	4	YO42	SE 74301 48126
21	Hogweed	23/7/12	5	YO42	SE 73987 48206
22	Hogweed	23/7/12	4	YO42	SE 74301 48126
23	Cow parsley	23/7/12	2	YO42	SE 73972 47615
24	Cow parsley	23/7/12	6	YO42	SE 74270 48331
25	Hogweed	23/7/12	3	YO42	SE 74185 47680
26	Hogweed	23/7/12	6	YO42	SE 74270 48331
27	Cow parsley	23/7/12	2	YO42	SE 73972 47615
28	Cow parsley	23/7/12	3	YO42	SE 74185 47680
29	Cow parsley	23/7/12	3	YO42	SE 74185 47680
30	Hogweed	23/7/12	5	YO42	SE 73987 48206
31	Hogweed	17/8/12	1	YO10	SE 64428 49418
32	Cow parsley	17/8/12	1	YO10	SE 64428 49418
33	Rough chervil	17/8/12	1	YO10	SE 64428 49418
34	Hogweed	17/8/12	1	YO10	SE 64428 49418
35	Hogweed	17/8/12	1	YO10	SE 64428 49418
36	Cow parsley	17/8/12	1	YO10	SE 64428 49418
37	Hogweed	17/8/12	1	YO10	SE 64428 49418
38	Hogweed	17/8/12	1	YO10	SE 64428 49418

39	Hogweed	17/8/12	1	YO10	SE 64428 49418
40	Hogweed	17/8/12	1	YO10	SE 64428 49418
41	Hogweed	17/8/12	1	YO10	SE 64428 49418
42	Cow parsley	17/8/12	2	YO10	SE 64232 49019
43	Hogweed	17/8/12	2	YO10	SE 64232 49019
44	Cow parsley	17/8/12	2	YO10	SE 64232 49019
45	Hogweed	17/8/12	2	YO10	SE 64232 49019
46	Hogweed	17/8/12	2	YO10	SE 64232 49019
47	Hogweed	17/8/12	2	YO10	SE 64232 49019
48	Hogweed	17/8/12	2	YO10	SE 64232 49019
49	Hogweed	17/8/12	2	YO10	SE 64232 49019
50	Hogweed	17/8/12	5	YO42	SE 73987 48206
51	Hogweed	17/8/12	5	YO42	SE 73987 48206
52	Hogweed	17/8/12	5	YO42	SE 73987 48206
53	Hogweed	17/8/12	5	YO42	SE 73987 48206
54	Rough chervil	17/8/12	6	YO42	SE 74270 48331
55	Cow parsley	17/8/12	6	YO42	SE 74270 48331
56	Hogweed	17/8/12	6	YO42	SE 74270 48331
57	Hogweed	17/8/12	6	YO42	SE 74270 48331
58	Rough chervil	17/8/12	6	YO42	SE 74270 48331
59	Hogweed	17/8/12	6	YO42	SE 74270 48331
60	Hogweed	17/8/12	6	YO42	SE 74270 48331
61	Hogweed	17/8/12	6	YO42	SE 74270 48331
62	Cow parsley	17/9/12	2	YO42	SE 73972 47615
63	Cow parsley	17/9/12	2	YO42	SE 73972 47615
64	Cow parsley	17/9/12	2	YO42	SE 73972 47615
65	Cow parsley	17/9/12	3	YO42	SE 74185 47680
66	Cow parsley	17/9/12	3	YO42	SE 74185 47680
67	Cow parsley	17/9/12	3	YO42	SE 74185 47680
68	Cow parsley	17/9/12	3	YO42	SE 74185 47680
69	Cow parsley	17/9/12	4A	YO42	SE 74298 47946
70	Cow parsley	17/9/12	4A	YO42	SE 74298 47946
71	Cow parsley	17/9/12	5	YO42	SE 73987 48206
72	Cow parsley	17/9/12	5	YO42	SE 73987 48206
73	Hogweed	17/9/12	1	YO42	SE 74106 47336
74	Hogweed	17/9/12	1	YO42	SE 74106 47336
75	Hogweed	17/9/12	1	YO42	SE 74106 47336
76	Hogweed	17/9/12	1	YO42	SE 74106 47336
77	Hogweed	17/9/12	1	YO42	SE 74106 47336
78	Hogweed	17/9/12	1	YO42	SE 74106 47336
79	Hogweed	17/9/12	1	YO42	SE 74106 47336
80	Hogweed	17/9/12	2	YO42	SE 73972 47615
81	Hogweed	17/9/12	2	YO42	SE 73972 47615
82	Hogweed	17/9/12	2	YO42	SE 73972 47615
83	Hogweed	17/9/12	2	YO42	SE 73972 47615
84	Hogweed	17/9/12	2	YO42	SE 73972 47615

85	Hogweed	17/9/12	3	YO42	SE 74185 47680
86	Hogweed	17/9/12	3	YO42	SE 74185 47680
87	Hogweed	17/9/12	3	YO42	SE 74185 47680
88	Hogweed	17/9/12	3	YO42	SE 74185 47680
89	Hogweed	17/9/12	4A	YO42	SE 74298 47946
90	Hogweed	17/9/12	4A	YO42	SE 74298 47946
91	Hogweed	17/9/12	4A	YO42	SE 74298 47946
92	Hogweed	17/9/12	5	YO42	SE 73987 48206
93	Hogweed	17/9/12	5	YO42	SE 73987 48206
94	Hogweed	17/9/12	5	YO42	SE 73987 48206

Appendix 2

Table 8: Estimates of prevalence of virus and necrosis and the effect of virus removal on reducing necrosis (values in brackets are 95% confidence intervals).

Virus	P(V N) (%)	P(V ~N) (%)	P(V) (%)	P(N V) (%)	P(N ~V) (%)	E (%)
PYFV	2.0 (0.4–6.1)	6.1 (2.6–12.1)	5.9 (2.5–12.0)	1.0 (0.1–4.2)	3.1 (2.5–3.8)	-4.2 (-10.3–1.3)
CtRLV	32.4 (23.9–41.8)	27.3 (19.2–36.6)	27.4 (19.7–36.3)	3.5 (2.2–5.5)	2.8 (2.1–3.6)	6.8 (-11.3–21.8)
CtRLVaRNA	0.0 (0.0–2.9)	0.0 (0.0–3.0)	0.0 (0.0–3.5)	NE	NE	NE
CMoV	8.8 (4.5–15.5)	14.1 (8.3–22.0)	14 (8.3–21.9)	1.9 (0.8–4.2)	3.2 (2.5–3.9)	-6.0 (-17–3.7)
CYLV	97.1 (92.4–99.2)	22.2 (14.9–31.1)	24.5 (17.1–33.1)	12.0 (8.4–17.1)	0.1 (0.0–0.3)	96.1 (89.6–98.8)
Any positive	98 (93.9–99.6)	52.5 (42.7–62.2)	53.9 (44.3–63.5)	5.5 (4.2–7.1)	0.1 (0.0–0.4)	95.7 (86.5–99.1)
CtRLV+CMoV	0.0 (0.0–2.9)	4.0 (1.4–9.3)	3.9 (1.4–9.1)	0.0 (0–17)	3.1 (2.5–3.7)	-4.1 (-9.2–0.4)
PYFV+CMoV	0.0 (0.0–2.9)	1.0 (0.1–4.6)	1.0 (0.1–4.6)	0.0 (0–17)	3.0 (2.4–3.6)	-1.0 (-4.2–2.5)
PYFV+CtRLV	0.0 (0.0–2.9)	1.0 (0.1–4.6)	1.0 (0.1–4.6)	0.0 (0–17)	3.0 (2.4–3.6)	-1.0 (-4.1–2.6)
PYFV+CYLV	1.0 (0.1–4.5)	0.0 (0.0–3.0)	0.0 (0–3.7)	100 (0.4–100)	3.0 (2.4–3.6)	1.0 (-2.5–3.7)
CtRLV+CYLV	26.5 (18.7–35.6)	7.1 (3.2–13.4)	7.7 (3.9–13.7)	10.4 (5.2–21.7)	2.4 (1.9–3.0)	20.4 (10.2–30.4)
CMoV+CYLV	2.9 (0.8–7.6)	0.0 (0.0–3.0)	0.1 (0.1–3.5)	100 (2.2–100)	2.9 (2.4–3.5)	2.9 (-1.3–6.5)
PYFV+CtRLV+CMoV	0.0 (0.0–2.9)	1.0 (0.1–4.6)	1.0 (0.1–4.5)	0.0 (0.0–24.3)	3.0 (2.4–3.6)	-1.0 (-4.2–2.3)
CtRLV+CMoV+CYLV	4.9 (1.9–10.4)	1.0 (0.1–4.6)	1.1 (0.3–4.5)	13.1 (2.4–61)	2.9 (2.3–3.5)	3.8 (-0.8–9.1)
PYFV+CMoV+CYLV	1.0 (0.1–4.5)	0.0 (0.0–3.0)	0.0 (0.0–3.6)	100 (0.4–100)	3.0 (2.4–3.6)	1.0 (-2.8–3.8)

P(V|N): proportion of necrotic carrots with the virus, **P(V|~N)**: proportion of non-necrotic carrots with the virus, **P(V)** prevalence of virus across all carrots, **P(N|V)**: proportion of

carrots with the virus that are necrotic, **P(N|~V)**: proportion of carrots without the virus that are necrotic. **E**: estimated effect of removing the virus on the prevalence of necrosis expressed as a proportional reduction in the prevalence of necrosis, **NE**: not estimated